

August 2018

Biogas Quality Improvement Using Water Wash and Phosphorus Recovery as Struvite in Jones Island Wwtp

MD ABUL BASHAR

University of Wisconsin-Milwaukee

Follow this and additional works at: <https://dc.uwm.edu/etd>

 Part of the [Civil Engineering Commons](#), and the [Environmental Engineering Commons](#)

Recommended Citation

BASHAR, MD ABUL, "Biogas Quality Improvement Using Water Wash and Phosphorus Recovery as Struvite in Jones Island Wwtp" (2018). *Theses and Dissertations*. 1746.
<https://dc.uwm.edu/etd/1746>

This Thesis is brought to you for free and open access by UWM Digital Commons. It has been accepted for inclusion in Theses and Dissertations by an authorized administrator of UWM Digital Commons. For more information, please contact open-access@uwm.edu.

BIOGAS QUALITY IMPROVEMENT USING WATER WASH
AND PHOSPHORUS RECOVERY AS STRUVITE IN JONES
ISLAND WWTP

by
Md Abul Bashar

A Thesis Submitted in
Partial Fulfillment of the
Requirements for the Degree of

Master of Science
in Engineering

at
The University of Wisconsin-Milwaukee
August 2018

ABSTRACT

BIOGAS QUALITY IMPROVEMENT USING WATER WASH AND PHOSPHORUS RECOVERY AS STRUVITE IN JONES ISLAND WWTP

by
Md Abul Bashar

The University of Wisconsin-Milwaukee, 2018
Under the Supervision of Professor Jin Li

Raw biogas from anaerobic digestion has a methane content of 50 to 60% and a carbon dioxide content of 40 to 50% on a molar basis (Bortoluzzi, Gatti, Sogni, & Consonni, 2014). Milwaukee Metropolitan Sewerage District (MMSD)'s Jones Island Waste Water Treatment Plant (WWTP) uses the biogas supplied from South Shore WWTP in drying Milorganite, a slow-release phosphate fertilizer. But with only 45% methane, the gas cannot be used for sophisticated purposes. To maximize its potential as energy source, the methane content must be upgraded to its market competitor natural gas. Based on simulation results from Aspen Plus software - High Pressure Water Scrubbing (HPWS) or water wash seems to be the best option. The process requires running the impure gas through pressurized water. Based on Henry's law, CO₂ is dissolved easily because of low partial pressure. The integrated process doesn't need additional water or pressure, as it can use wastewater from WWTP and the gas is already supplied at an optimal pressure. It can also remove most of the H₂S, present as a trace amount in the biogas. Furthermore, struvite, a better-quality phosphate fertilizer can be recovered with adequate aeration and adding NaOH. From simulation results, the methane content can be improved up to 98.7 % at pressures up to 150 psi.

Key Words: Biogas, Water Wash, Struvite, Anaerobic Digestion, Aspen Plus Simulation

TABLE OF CONTENTS

ABSTRACT	ii
LIST OF FIGURES	v
LIST OF TABLES	vii
LIST OF ABBREVIATIONS	viii
ACKNOWLEDGEMENTS	ix
CHAPTER I: INTRODUCTION	1
CHAPTER II: LITERATURE REVIEW	2
BIOGAS WATERWASH	2
COMPONENTS OF BIOGAS	2
Primary Components	2
Methane	3
Carbon Dioxide.....	5
Hydrogen Sulfide.....	6
Other Trace Components.....	7
FACTORS AFFECTING BIOGAS CAPTURE IN WATER WASH	7
Solubility and Henry’s Law.....	7
Pressure.....	9
Temperature.....	10
Relation Between Factors.....	10
DIFFERENT METHODS OF BIOGAS PURIFICATION	12
Amine-Based Chemical Absorption (CHEM).....	12
Organic Solvent-Based Physical Absorption (PHY).....	15
Water Wash (WW)	17
Pressure Swing Adsorption (PSA)	21
Membrane Separation.....	23
Comparison Between Upgrading Technologies	27
MECHANICAL COMPONENTS OF WATER WASH	27
Absorber	27
Flash.....	29
Compressor.....	30

Cooler	30
Stripper	31
PHOSPHORUS RECOVERY AS STRUVITE	32
PHOSPHORUS RECOVERY	32
Importance of Phosphorus Recovery	32
Significance of Struvite for MMSD	33
AVAILABLE PHOSPHORUS RECOVERY TECHNOLOGIES	34
Crystal Green	34
Struvite Recovery in Canada	34
Struvite Recovery in US (HRSD, Virginia)	37
Struvite Recovery in UK	39
CHAPTER III: EXPERIMENTAL MODELING AND CALCULATION	40
ASPEN PLUS SIMULATION OF BIOGAS WATERWASH	40
RESULTS OF SIMULATION	43
Result of Simulation for Pilot Scale	46
Result of Simulation for Full Scale	47
CALCULATION FOR PHOSPHORUS RECOVERY	50
CHAPTER IV: PROPOSED MODIFICATION OF JIWWTP	57
CHAPTER V: RESULTS AND DISCUSSION	59
REFERENCES	61

LIST OF FIGURES

Figure 2. 1: (a) Map based on the gridded 2012 methane data – National Total ; (b) Map based on the gridded 2012 methane data – Agricultural and (c) Map based on the gridded 2012 methane data – WWTP & Landfill, Source: (Maasackers et al., 2016).	5
Figure 2. 2: Solubility of carbon dioxide in high pressures under different temperatures ($\circ 0^{\circ}\text{C}$; $\square 10^{\circ}\text{C}$; $\Delta 20^{\circ}\text{C}$) (Pierantozzi, 2003).	8
Figure 2. 4: Amine-Based Chemical Absorption. Illustration Credit: (Mazari et al., 2015)	13
Figure 2. 5: CO_2 Absorption in Amines. Chart Credit: (Lallemand et al., 2012)	13
Figure 2. 6: Physical Solvent Scrubber Process Diagram. Illustration Credit: (ÖKOBIT GmbH, 2014)	16
Figure 2. 7: Biogas Water Scrubber System Design. Illustration Credit: (Hudde, 2010)	19
Figure 2. 8: Pressure Swing Adsorption Process Diagram. Source: (Zhao et al., 2010)	22
Figure 2. 9: Gas Separation Membrane Permeation Rates. Source: (Suda & Haraya, 1997)	23
Figure 2. 10: (i) Schematic representation of the separation principle (ii) Two-stage process with recycle and a compressor [Raw biogas (Rohbiogas) enters the system from left]. Illustration Credit: (Harasek, 2006)	24
Figure 2. 11: Biogas Production to Supply Using High-Pressure Gas Separation Membrane Design at DMT-CGS	26
Figure 2. 12: Random Packing (left) and Mellapak Structured Packing (right). Source: sulzer.com	28
Figure 2. 13: Schematic Diagram of WW Treatment with Struvite Recovery (AT Britton et al., 2007)	35
Figure 2. 14: Struvite pP_s in digester supernatant and distilled water as a function of pH	36

Figure 2. 15: Typical Layout of Nansemond Treatment Plant (HRSD), Virginia.....	37
Figure 2. 16: Struvite Recovery at Nansemond Treatment Plant (HRSD), Virginia. Source: Hazen and Sawyer	38
Figure 3. 1: Solubility of biogas components in water: (a) CO ₂ , (b) CH ₄ , (c) H ₂ S, (d) N ₂ , (e) O ₂ (adapted upon Cozma et al. 2013; reproduced from Environmental Engineering and Management Journal) (Mao et al. 2011).....	42
Figure 3. 2: ASPEN PLUS Flow Diagram with two absorbers.....	43
Figure 3. 3: Column Internal for absorber 1.	44
Figure 3. 4: Column Internal for absorber 2.	44
Figure 3. 5: Hydraulic Plot for Absorber Column 1.	45
Figure 3. 6: Hydraulic Plot for Absorber Column 2.	45
Figure 3. 7: Pilot Scale Biogas water wash simulation result at varying temperature.....	47
Figure 3. 8: Full Scale Biogas simulation result at varying temperature at 45psi	48
Figure 3. 9: Full Scale Biogas simulation result at varying temperature at 150psi	48
Figure 3. 10: MMSD’s Jones Island waste water influent data for a. phosphorus b. Ammonia c. BOD & COD and d. Magnesium.....	51
Figure 3. 11: Dissolved PO ₄ -P concentrations in anaerobic effluent solutions from the LW lagoon (a) and RM lagoon (b) after equilibrating for 24 h and forming struvite. Curves are predicted PO ₄ -P concentrations using multiple linear regression.....	52
Figure 3. 12: Biogas Waterwash at 87 psi with varying temperature [Aspen Plus Modeling].....	54
Figure 3. 13: Total Phosphorus in Sludge as % of Dry Weight [Source: MMSD]	55
Figure 4. 1: Existing Jones Island Biosolids Facility [Source: MMSD].....	57
Figure 4. 2: Proposed Simplified Jones Island Biosolids Facility	57

LIST OF TABLES

Table 2. 1: Content of methane, carbon dioxide, oxygen, nitrogen, and hydrogen sulfide in biogas from the different biogas producing plants in Norway	3
Table 2. 2: Different components of Biogas and their Henry's Law Constant.....	9
Table 2. 3: Comparison Between Biogas Upgrading Technologies. [Source: (Beil & Beyrich, 2013); (Severn Wye Energy Agency, 2013); (Starr, Gabarrell, Villalba, Talens, & Lombardi, 2012)].....	27
Table 2. 4: Chemical Composition of Struvite	33
Table 2.5: Summary of pilot scale struvite recovery test run results. Results are average for each test run. Source: (AT Britton et al., 2007)	35
Table 3. 1: Summary of Simulation Input for Pilot Scale.....	46
Table 3. 2: Pilot Scale simulation data at 60°F Temperature and 45 psi pressure	46
Table 3. 3: Simulation result for Pilot of Biogas water wash at varying temperature	46
Table 3. 4: Full Scale Biogas simulation result at varying temperature at 45psi.....	47
Table 3. 5: Full Scale Biogas simulation result at varying temperature at 150psi.....	48

LIST OF ABBREVIATIONS

HPWS	High Pressure Water Scrubbing
WW	Water Wash
PSA	Pressure Swing Absorption
MMSD	Milwaukee Metropolitan Sewerage District
WWTP	Waste Water Treatment Plant
WAS	Waste Activated Sludge
DMS	Dimethyl Sulfide
EOR	Enhanced Oil Recovery
VOC	Volatile Organic Compounds
TS	Total Solids
MEA	Monoethanolamine
MDEA	Methyldiethanolamine
AMP	2-amino-2-methyl-1-propanol
SHA	Sterically Hindered Amine
PIP	Piperidine
PZ	Piperazine
PZEA	Piperazinyl-1,2-ethylamine
IPCC	Intergovernmental Panel on Climate Change
CMS	Carbon Molecular Sieve
BNR	Biological Nutrient Removal
MGD	Million Gallons per Day

ACKNOWLEDGEMENTS

First, I would like to thank my thesis advisor Dr. Jin Li of the Department of Civil and Environmental Engineering for her tireless effort with my thesis. She has been an inspiration and a mentor for my higher education. I wouldn't be here without her faith in me. She has always been helpful to me with guidelines, conference information and technical supports. She also helped me with the expensive but very important Aspen Plus software which was crucial for this study.

I would also like to thank Mr. Bryan Johnson from Energy Tech Innovations and Mr. Matt Magruder from MMSD for providing valuable data used in this study. Without their passionate effort and valued input, this work could not have been successfully performed.

I would also like to acknowledge Prof Qian Liao of the Civil and Environmental Engineering and Prof Timothy Grundl of Department of Geosciences at University of Wisconsin Milwaukee as the thesis committee members. I am grateful for their valuable input on this thesis.

Finally, I'm thankful to my parents, friends and well-wishers for their continuous support. I'm indebted and humbled for their trust in me.

CHAPTER I: INTRODUCTION

Methane has a high energy content of 55.5 MJ/kg compared to 46.4 MJ/kg for gasoline. To gain the possible maximum amount of energy, biogas should be as pure as possible. Depending on source raw biogas from anaerobic digestion has a methane content of 50 to 60 % and carbon dioxide of 40 to 50 % on a molar basis (Bortoluzzi et al., 2014). To maximize the its potential as an energy source, the methane content must be upgraded to match its market competitor natural gas. Comparing to other energy sources such as coal and gasoline, biogas has only one major pollutant – CO₂. If CO₂ is removed, then biogas can be used in the national gas grid or can be used for any industrial purpose. Luckily, removing CO₂ is not complex. Simulated results of Aspen Plus software and the pilot project, High Pressure Water Scrubbing (HPWS) also known as Water Wash seems to be the best option. It is essentially running the impure gas through pressurized water. The process depends on the fact that, CO₂ has a lower partial pressure than methane. One major advantage of water scrubbing is that the entire process relies on readily available substances like water and no other chemical is needed. It can also remove trace amount of H₂S present in biogas. From our simulated result, the methane content can be improved as high as 98.7% at a pressure of 150 psi.

Considerable attention has been given in recent years to the impact of gasoline on air quality specifically as it relates to the toxic pollutants including carbon monoxide and lead while coal contains heavy metals and potential toxic substances (Gaffney & Marley, 2009). Natural gas is more efficient and emits 50 to 60 percent less carbon dioxide when combusted in a new, efficient natural gas power plant compared with emissions from a typical new coal plant (NETL, 2013). From financial point of view, natural gas and biogas are close in competitiveness. Considering the projected electricity and natural gas prices and the value of offsetting energy purchases, using biogas for electricity production may be more profitable than supplying it to the pipeline (Murray, Galik, & Vegh, 2014). After treatment, biogas also can reach a higher methane content of 98% which is comparable to typical natural gas supply of 90 to 95% methane with 4 to 7% higher hydrocarbon (US5390499A, 1993). With our proposed technology, homeowners and small businesses can install their own biogas purification plant with minimal cost.

CHAPTER II: LITERATURE REVIEW

BIOGAS WATERWASH

COMPONENTS OF BIOGAS

Primary Components

Biogas is produced in different environments and WWTP is one of the best and readily available sources. In landfills and in WWTPs, biogas is naturally produced by anaerobic degradation of organic materials. Usually biogas contains 45-70 % methane (CH₄) and 30-45 % carbon dioxide (CO₂), very little amount of nitrogen (N₂) and trace amount of hydrogen sulfide (H₂S). The main component methane is a reliable source of energy and is produced with very minimal cost but can be detrimental for the environment if released to atmosphere. Some countries burn the raw gas because there is a lack of good purification process for biogas. Even though it's not an innocuous solution as it produces carbon dioxide but methane is roughly 30 times more potent as a heat-trapping gas.

Biogas from sewage digesters of WWTP typically has higher methane content than landfill or biogas plant. It usually contains 55-65 % methane, 35-45 % carbon dioxide and < 1 % nitrogen and negligible amount of hydrogen sulfide. Biogas from organic waste digesters usually contains from 60-70 % methane, 30-40 % carbon dioxide and < 1 % nitrogen, while in landfills methane content is usually from 45 to 55 %, carbon dioxide from 30-40 % and nitrogen from 5-15 % (Jönsson et al., 2003). In Germany the typical biogas plant has methane content of about 53.7%, carbon dioxide 45.2% and hydrogen sulfide 101.8 ppm (Götz, Köppel, Reimert, & Graf, 2012).

Table 2.1 shows the biogas component variation depending on its source in plants located in Scandinavia(Rasi, 2009).

Type of Plant	CH ₄ [%]	CO ₂ [%]	O ₂ [%]	N ₂ [%]	H ₂ S [ppm]
Landfills:					
Mustankorkea	47-57	37-43	<1	<1-17	36-230
Koukkujarvi	47-62	37-41	n.a.	n.a.	27-32
Tarastenjarvi 1	49-57	32-35	n.a.	n.a.	108-125
Tarastenjarvi 2	51-61	35-37	n.a.	n.a.	53-84
Ammassuo	50-52	36-38	n.a.	n.a.	300-500
WWTPs					
Jayvaskyla	60-65	34-38	<1	<1	<1-4
Tampere 1	61-67	33-38	n.a.	n.a.	2-4
Tampere 2	61-66	35-36	n.a.	n.a.	<1-2
Espoo	64-66	34-36	n.a.	n.a.	<1-2
Biogas Plants					
Kupferzell	56	n.a.	n.a.	n.a.	300
Remlingen	55	44	n.a.	n.a.	300
Vaasa	56-65	38-40	n.a.	n.a.	500-1000
Ilmajoki	65-70	29	n.a.	n.a.	3-5
Laukaa	55-58	37-38	<1	<1-2	32-169

Table 2. 1: Content of methane, carbon dioxide, oxygen, nitrogen, and hydrogen sulfide in biogas from the different biogas producing plants in Norway

Methane

The simplest alkane methane is one of the most readily available gas naturally found in the atmosphere. As the main component of natural gas methane has heat of combustion of 55.5 MJ/kg. Based on data from 1990 to 2012, U.S. methane emission dropped from 635.2 TgCO₂e to 567.3 TgCO₂e (Murray et al., 2014). The trend continues for U.S. methane emissions from landfills as it decreased from 147.8 TgCO₂e to 102.8 TgCO₂e. But, U.S. methane emissions from WWTPs remained rather stable around 13 TgCO₂e. U.S. methane emissions from manure management has increased from 31.5 TgCO₂e to 52.9 TgCO₂e due to the increasing use of liquid systems facilitated by a shift to larger facilities (EPA, 1999).

In fact, the U.S. has the highest methane emissions from manure management of any country—twice as much as second and third place, India and China, respectively. Yet, this only accounts for about 9% of the U.S.’s total methane emissions (EPA, 2015).

Under the United Nations Framework Convention on Climate Change (UNFCCC), every country must report their national anthropogenic greenhouse gas emissions (or gas emission caused by human activity) calculated using similar methods (United Nations, 1992).

It says,

Article 4

(1)

All Parties, taking into account their common but differentiated responsibilities and their specific national and regional development priorities, objectives and circumstances, shall:

(a).

Develop, periodically update, publish and make available to the Conference of the Parties, in accordance with Article 12, national inventories of anthropogenic emissions by sources and removals by sinks of all greenhouse gases not controlled by the Montreal Protocol, using comparable methodologies to be agreed upon by the Conference of the Parties;

The Intergovernmental Panel on Climate Change (IPCC) provides three different methods or “tiers” for calculating emissions (IPCC, 2008). All are bottom-up approaches in which emissions from individual source types are generally calculated as the product of activity data and emission factors. Based on the data provided by (Maasackers et al., 2016) the national total methane emission is shown in the following Map.

Gridded EPA Inventory for 2012

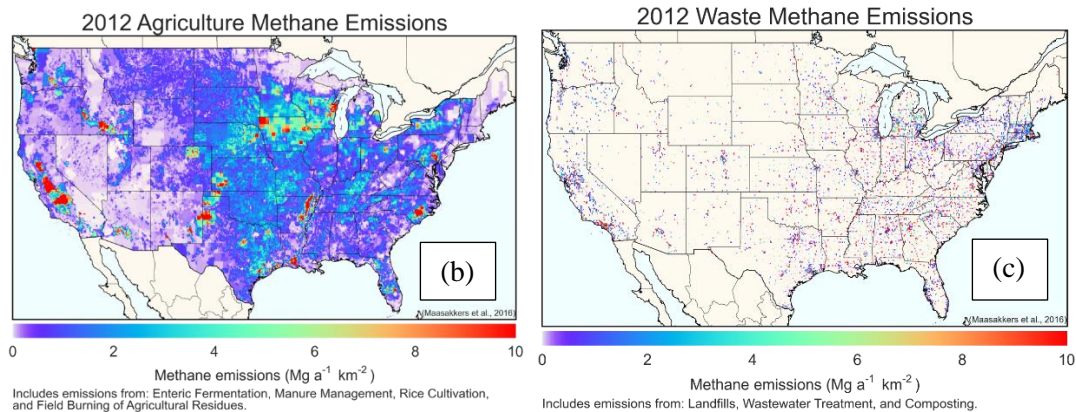
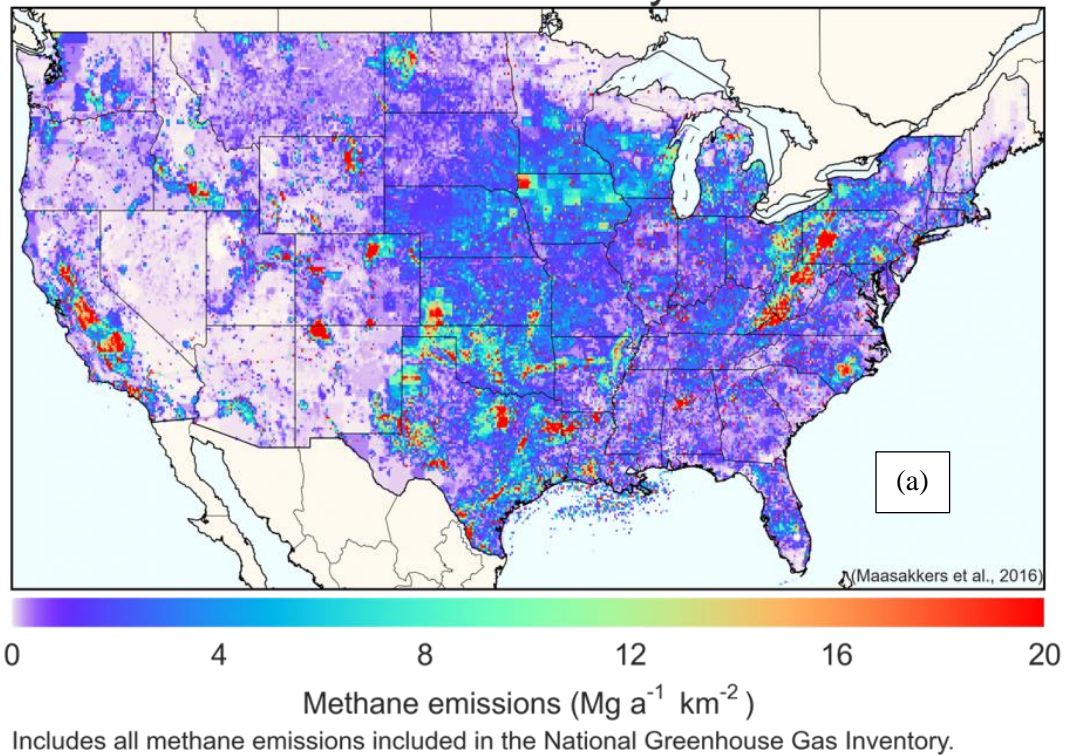

Figure 2. 1: (a) Map based on the gridded 2012 methane data – National Total ; (b) Map based on the gridded 2012 methane data – Agricultural and (c) Map based on the gridded 2012 methane data – WWTP & Landfill, Source: (Maasakkers et al., 2016).

Carbon Dioxide

When sludge from wastewater is kept under anaerobic condition, hydrogen sulfide and other sulfide compounds are produced in biogas in several different ways (Wilber &

Murray, 1990). For instance, degradation of sulfur containing amino acids forms methanethiol and dimethyl sulfide (DMS). When DMS is reduced after methanogenic conversion, methane and methanethiol are formed. This methanethiol later forms the basic components of biogas - methane, carbon dioxide and hydrogen sulfide (Lomans, Pol, & Op den Camp, 2002).

The separation of carbon dioxide from nitrogen or hydrogen has been the center of attention in recent years for gas separation and membrane research. The reason is the necessity and requirement to reduce carbon dioxide emissions to tackle the greenhouse gas effect and global temperature rise. Any source of carbon dioxide production should be focused in reducing emission. Wastewater treatment plants and landfills are not the biggest players in carbon dioxide emission, but fossil fuel fired power plants are. (Czyperek et al., 2010)(Merkel, Lin, Wei, & Baker, 2010)

Hydrogen Sulfide

The biogas water wash process can remove halogenated and sulfur compounds from the landfill gas at a low pressure, although higher pressure would need significantly lower water flow. The study by Rasi (2009) concludes at 290 psi (20 bar) most sulfides can be removed albeit these concentrations in the raw gas were low compared to those found in other studies (Stoddart et al., 1999)(Shin et al., 2002). The presence of sulfur compounds in biogas is especially harmful because they are corrosive in the presence of free water or the moisture, which is easily available in the engine oil, and/or landfill gas. These compounds wear out the engine piston rings as well as cylinder linings. This also affects oil quality, leading to the need for more frequent oil changes (SEPA, 2004). Overall lower than the concentrations of over 250 mg organic Cl/Nm³ and over 1500 ppm of hydrogen sulfide considered damaging (corrosive) to gas engines (Stoddart et al., 1999). To use the gas in vehicles and to add it into the natural gas grid harsher limits have to be satisfied, < 23 mg/m³ or < 30 mg/m³ for total sulfur, < 1 mg/m³ for chlorine and < 10 mg/m³ for fluorine (Persson et al. 2006). Apart from all that, engine manufacturers have set minimum limits on methane content to ensure engine performance. Most manufacturers for light-duty stoichiometric engines currently specify between 85 and 90 percent minimum

methane content, between 2 and 9 percent maximum propane content and between 1 and 5 percent maximum butane content. The methane content of 95 is mandatory for heavy duty engines such as turbo charged engines (Bradley, 2005).

Other Trace Components

Halogenated compounds are other impurities that need to be mentioned although most often they are found in landfill gases and their presence is uncommon in biogases produced from sewage sludge or organic wastes. Organochlorides become a major issue when biogas is used for energy production as they cause corrosion in vehicle or combustion engines as well as forming dioxins and furans under certain conditions (Persson et al. 2006). The other concern is aromatic and chlorinated compounds. Those have been heavily used in industry as solvents while fluorinated compounds have been used as refrigerating aggregates, foaming agents, solvents and propellants (Scheutz, Mosbaek, & Kjeldsen, 2004). So, it depends on the levels of alkanes and aromatic compounds as well as those of halogenated and oxygenated compounds that are present in the composition and stage of decomposition of waste (Allen, Braithwaite, & Hills, 1997). Allen et al. (1997) and (Jaffrin, Bentounes, Joan, & Makhlouf, 2003) detected total chloride in amounts from 118 to 735 and 169 mg/m³ and total fluorine in amounts from 63 to 256 and 25.9 mg/m³ in their studies on halocarbons in landfill gases.

FACTORS AFFECTING BIOGAS CAPTURE IN WATER WASH

Solubility and Henry's Law

Henry's law is the relationship between the partial pressure and solubility in a gas-liquid system. Introduced by English chemist William Henry, it states that, the solubility of gas into water is dependent on factors such as pressure, temperature, liquid/gas ratio etc. According to Henry's law there is a linear relationship between the partial pressure of a gas and its concentration in dilute solution:

$$P_A = X_A * H_A \dots\dots\dots(2.1)$$

Where, P_A = vapor pressure of component A above the liquid mixture,

X_A = mole fraction of A in the liquid mixture,

and H_A = Henry's law constant

The relationship works best at low pressure. At higher pressures Henry's law is no longer valid in its simple form (Lekvam & Bishnoi, 1997), and temperature becomes a more crucial factor than pressure for gas solubility (Pierantozzi, 2003). Carbon dioxide solubility is the focus of this study as it is the principal contaminant in raw biogas. Carbon dioxide solubility at high pressures under different temperatures is given in Figure 2.2

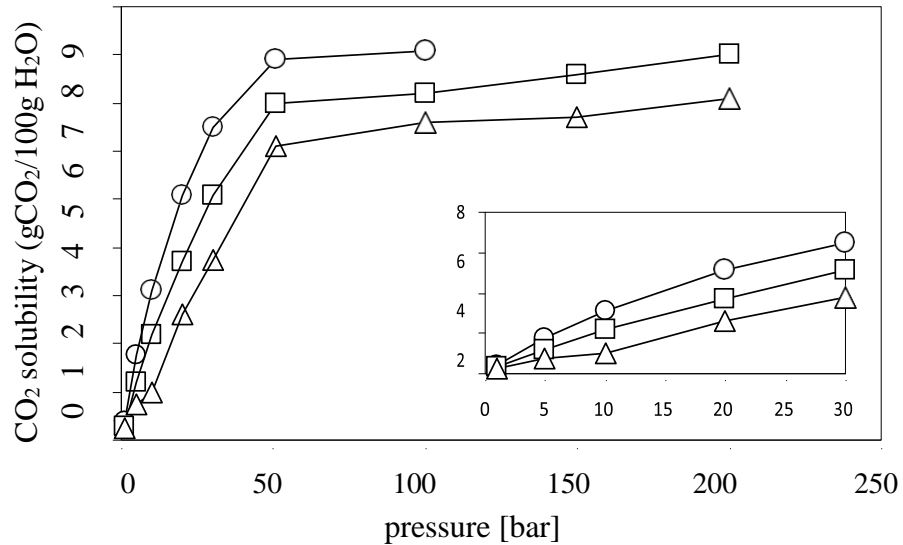

Figure 2. 2: Solubility of carbon dioxide in high pressures under different temperatures (○ 0°C; □ 10 °C; Δ20°C) (Pierantozzi, 2003).

Figure 2.2 shows that the relationship between pressure and solubility is nonlinear after 50 psi, which means higher pressure, is not necessarily the solution for biogas water wash. The combination of pressure and temperature is important.

Henry's law also helps to understand the solubility of methane, sulfur dioxide and nitrogen in water. Because methane has a very low partial pressure as compared to H₂S or CO₂, it'll escape the system at moderate pressure. H₂S has a very high partial pressure and stays dissolved in water almost entirely and so does most of the carbon dioxide.

Following is the list of Henry's law constants for different gasses from various sources. The table indicates similar K_H value for the selected gasses.

Component	Henry's Law Constant (K_H)	Source
Carbon Dioxide (CO ₂)	3.4×10 ⁻²	(Jacob, 1986)
	3.4×10 ⁻²	(Lelieveld & Crutzen, 1991)
	3.5×10 ⁻²	(Lide, 1998)
	3.6×10 ⁻²	(Zheng, Guo, & Knapp, 1997)
Methane (CH ₄)	1.5×10 ⁻³	(Hine & Mookerjee, 1975)
	1.3×10 ⁻³	(Mackay & Shiu, 1981)
	1.5×10 ⁻³	(Yaws, 1999)
	1.4×10 ⁻³	(Lide, 1998)
Hydrogen Sulfide (H ₂ S)	1.0×10 ⁻¹	(Edwards, Maurer, Newman, & Prausnitz, 1978)
	1.0×10 ⁻¹	(Carroll & Mather, 1989)
	1.0×10 ⁻¹	(Dean, 1990)
	1.0×10 ⁻¹	(Lide, 1998)
Nitrogen (N ₂)	6.5×10 ⁻⁴	(Wilhelm, Battino, & Wilcock, 1977)
	6.1×10 ⁻⁴	(Kavanaugh & Trussell, 1980)

Table 2. 2: Different components of Biogas and their Henry's Law Constant

Pressure

Pressure is the most important factor in biogas purification when pressure swing absorption (PSA) or water wash/water scrubbing (WW) is used as means of treatment. Pressure swing is a solid adsorbent-based process that relies on the selective adsorption of carbon dioxide on the surface of special porous solid adsorbents. At elevated pressure the adsorption occurs, and separation occurs when the pressure is reduced on the adsorbent. On the other hand, water wash is liquid based, when pressurized gas flows through water, CO₂ and other impurities are absorbed in water. Liquids other than water are used in absorption processes, and in some locations membrane technology is used (Persson, Jonsson, & Wellinger, 2007). As the upgrading of biogases from sewage and biowaste digesters is rapidly increasing in some countries (Appels, Baeyens, Degreè, & Dewil, 2008) it becomes important that an integrated water treatment and biogas purification process is used. This

study analyzes the possible ways that can be achieved. The colder climate of midwestern United States and its impact on the selected process has also been considered.

Henry's constant is an indirect measurement of the solubility of a gas in liquid. The solubility is influenced by temperature, pressure, and system type used in absorption. The solubility decreases with increasing temperature and increases with increasing pressure. It is anticipated that CO₂ capture (%) will increase by increasing the feed biogas pressure in the absorption column and will decrease under low pressure because of the enhanced CO₂ solubility at higher pressures (Marzouk, Al-Marzouqi, El-Naas, Abdullatif, & Ismail, 2010).

Temperature

Temperature is the second most important factor after pressure in water wash as at higher pressure Henry's law doesn't accurately predict the absorption and with higher temperature it only makes the prediction worse. Temperature also plays a significant role in anaerobic digestion. Different microbial communities respond differently to the same feedstock. Biogas composition is mostly dependent upon its source (Williams, Kaffka, & Oglesby, 2014). Feedstock material, microbial communities, reactor conditions such as temperature and pH and operating parameters (e.g., hydraulic retention time) will produce minor variations in gas quality and composition.

The reason why solubility of gases varies with changing temperature is diffusion (Sjöstrand & Yazdi, 2009; Sohrabi, Marjani, Moradi, Davallo, & Shirazian, 2011). The solubility of gases in water decreases by increasing temperature, according to Henry's law, meanwhile the liquid-phase diffusion coefficients decrease with decreasing the temperature (Sohrabi et al., 2011), lowering the CO₂ removal efficiency.

Relation Between Factors

Physical absorption of gases in water is governed by Henry's Law, which implies knowledge of the solubility of biogas components in water is necessary. This is an essential condition for an optimum design and optimization of HPWS process (Cozma et al., 2014)

The Henry's constant for a specific gas is only valid at one specific temperature and plays a key role at higher pressure. After the temperature is increased, the solubility decreases and vice versa. The equation introduced by Dutch Chemist van't Hoff is one that can be used to get an approximation of how the solubility varies with the temperature (Sander, 2011).

$$K_H(T_2) = K_H(T_1) \exp \left[C \left(\frac{1}{T_2} - \frac{1}{T_1} \right) \right] \dots\dots\dots (2.2)$$

In Eq. 2.2, T_1 and T_2 are the absolute temperatures for the known and unknown constant respectively, and C is a specific coefficient which is defined as $C = d \ln(k_H) / d(1/T)$. For CO_2 in water, the value of C is 2400. Figure 2.3 shows how the solubility of CO_2 changes between $10^\circ C$ and $25^\circ C$ according to Eq. 2.2. As shown in the figure, the relative solubility is doubled at $10^\circ C$ than at $25^\circ C$. A similar graph was also published earlier (Petersson & Wellinger, 2009).

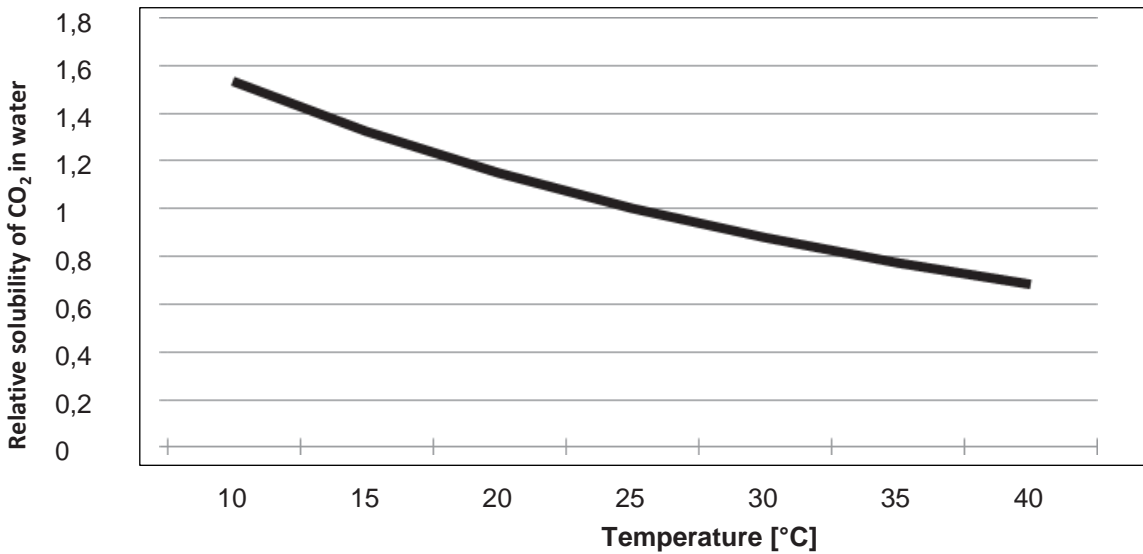

Figure 2. 3: Relative solubility of CO₂ in water in the temperature interval between $10^\circ C$ and $40^\circ C$. Solubility normalized to the value at $25^\circ C$.

Figure 2.3 Shows that the solubility falls sharply at lower temperature but at higher temperature it falls at a slower rate. This can have a profound impact on the treatment

process in the Midwest, where the average daytime temperature in the winter is generally 20-40°F (Adresen, Hilberg, & Kunkel, 2014) (Walsh, 2018)

DIFFERENT METHODS OF BIOGAS PURIFICATION

Amine-Based Chemical Absorption (CHEM)

In most commercial CO₂ capture processes an aqueous solution of MEA (amine-based solvent) is used (Singh, 1979). The commercialized amine-based chemical absorption technology for CO₂ capture is a reactive absorption by amines, such as monoethanolamine (MEA) and methyldiethanolamine (MDEA)(Li, Yan, & Campana, 2012). The CO₂ absorption process into amine-based solvents occurs in two steps: (i) in the absorption column, absorption of CO₂ happens by countercurrent contact between gas and solvent, and (ii) the solvent is regenerated of in a second column by heating supply releasing a concentrated CO₂ flux (Dubois & Thomas, 2012).

Separating CO₂ from flue streams gas got popularity in the 1970s and it was not because of the concern about the greenhouse effect. It became popular because of its potential as an economic source primarily from enhanced oil recovery (EOR) operations. Several commercial CO₂ capture plants were constructed in the U.S. in the late 1970s and early 1980s (DuPart, Bacon, & Edwards, 1993) For chemical absorption in gas treating the use of an alkanolamine based solution such as mono-ethanolamine (MEA) is still the preferred choice. But it's not perfect and alternative solvents are required when different aspects are taken into account, the aspects include absorption performances and energy consumption for solvent regeneration and solvent resistance to degradation (Eide-Haugmo et al., 2011)(Lepaumier, Picq, & Carrette, 2009).

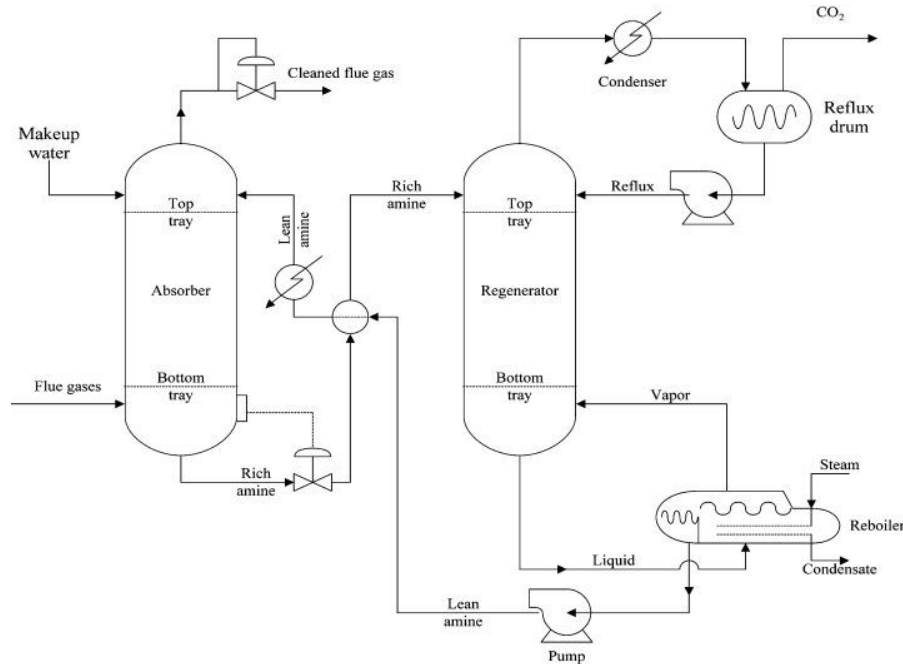

Figure 2. 3: Amine-Based Chemical Absorption. Illustration Credit: (Mazari et al., 2015)

Amine solutions includes monoethanolamine (MEA), a primary alkanolamine which is considered as benchmark in most studies; methyldiethanolamine (MDEA), a tertiary alkanolamine; 2-amino-2-methyl-1-propanol (AMP), a sterically hindered amine (SHA), and three cyclical amines usually applied as absorption activators, namely piperidine (PIP), a cyclical monoamine, piperazine (PZ), a cyclical diamine, and piperazinyl-1,2-ethylamine (PZEA), a cyclical triamine with the particularity of containing three amine functions (primary, secondary, and tertiary).

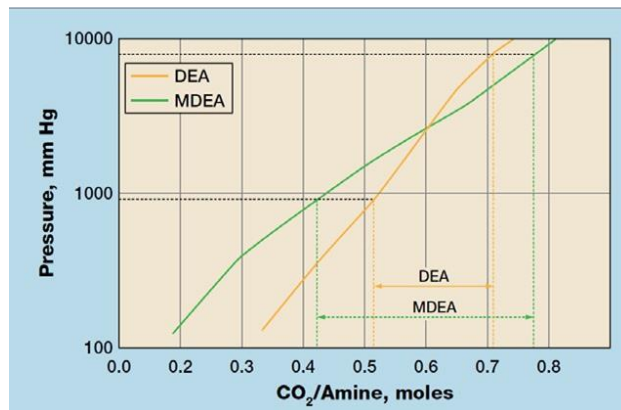

Figure 2. 4: CO₂ Absorption in Amines. Chart Credit: (Lallemand et al., 2012)

Chemical absorption ensures a total methane recovery while the water scrubbing has higher methane losses which means it depends more on the solvent flowrate than in the case of chemical absorption. Amines have a high selectivity and loading for CO₂ (Figure 2.5)—one to two orders of magnitude more CO₂ can be dissolved per unit volume in amines than in water. Since amine based absorption has low CH₄ absorption it also provides low methane slip, i.e. the methane lost to the off-gas stream, of 0.04 – 0.1%, which is an order of magnitude less than other absorption and scrubbing technologies (Murray et al., 2014).

However, amine-based absorption is not devoid of downsides. The two advantages of the chemical absorption here highlighted present a drawback: due to the lower pressure and the higher temperature in absorber, the purified gas coming from a chemical absorption has higher water content than the gas obtained from the water scrubbing or water wash. Among the MEA 30 % w/w solution and the MEA 15 % w/w solution, the last one ensures lower water content in the gas due to the lower absorption temperature. In addition to these factors, several other characteristics should be considered before deciding when and if water scrubbing is preferred over the chemical scrubbing.

Amine based absorption requires regeneration and an exhaustive technical-economic analysis is necessary to consider whether heating sources at no or moderate costs are available for this purpose or not, and the quantification of the revenue losses if a fraction of the produced biogas is used for the amine regeneration. As mentioned earlier amine-based absorption can have higher water content and the water content of the purified gas impacts on the subsequent gas drying facilities. As a result, if chemical scrubbing is used, the absorption pressure could be slightly increased in order to obtain an acceptable compromise between the drying costs and the costs due to the gas compression work.

Lastly, the pumping work for the solvent circulation must be considered which might be already included in water wash if integrated in a waste water treatment plant. So, lots of different factors must be considered when deciding what biogas upgrading purification should be preferred (also depending on the biogas source which, as in the case of biogas from municipal wastewater treatment plant sludge, could be linked to the absorbent source), but the correct calculation of the performances of the techniques to be potentially chosen is a necessary starting point (Gamba & Pellegrini, 2013).

Organic Solvent-Based Physical Absorption (PHY)

The impurities carbon dioxide and hydrogen sulfide can also be absorbed using organic liquid solvents other than water. Organic glycols are the most common absorbents in this case (e.g., polyethylene glycol). Physical organic solvents allow for greater H₂S and CO₂ solubility than in water, allowing for lower solvent demand and reduced pumping. The process can be greatly beneficial where water is not abundant for Waterwash. Glycols for scrubbing biogas are commercially found with such names as Genosorb® 1753, SELEXOL, Purisol, Rectisol, Ifpexol, and Sepasolv (Murray et al., 2014).

The physical absorption is comparable to water wash. To improve absorption, gas is compressed to 4 – 8 bar (around 60 – 115 psi) and the temperature is lowered to 10 – 20 °C (50 - 70°F). Physical solvent scrubbers also operate in a similar manner to water scrubbers, using counter-current flows and a packed media bed. It also has absorber and flash like water wash. To regenerate the saturated solvent, it passes through a flash column, heated to 40 – 80 °C, and then run through a packed air stripper/desorption column. Depending on the pressure and temperature and other factors the product gas is normally made to consist of 95 – 98% methane with 1.5 – 4% methane slip. To get the physical solvent back and reuse it in the system depressurization in a flash column is necessary. Along with pressure reduction, heating (40 – 80 °C), and steam or air stripping is also necessary to regenerate the solvent. Although the solvent can be regenerated, it cannot be used forever and needs eventual replacement, producing some hazardous liquid waste. However, only a minor addition of solvent roughly once a year is usually required. Also, the stripper exhaust gas cannot be released without treatment and must be treated by regenerative thermal oxidation (at 800 °C). Because its methane concentration is too low for flameless oxidation it cannot be burnt.

Figure 2.6 shows a typical layout of a physical absorption system. The raw biogas goes through the compressor after it goes through the H₂O separator. The compressed gas then goes through the absorber where methane is separated through the absorption of other gases. The impurity absorbed solvent then goes through the flash and stripper to regenerate purified form the solvent which can be reused in the system. The system has a heat

exchanger as maintaining right temperature has significant effect on the purification process.

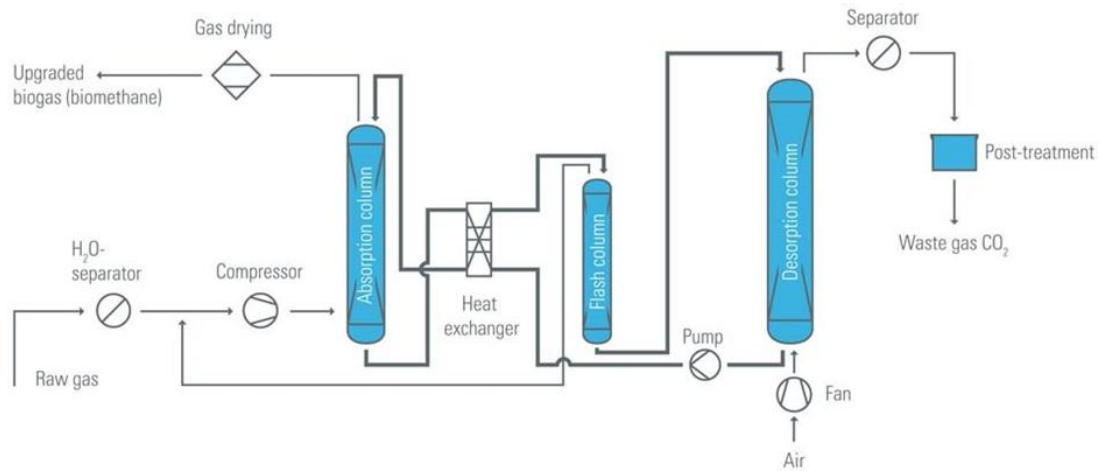

Figure 2. 5: Physical Solvent Scrubber Process Diagram. Illustration Credit: (ÖKOBIT GmbH, 2014)

When using glycols for physical absorption no precision desulphurization is generally required. Another advantage over water scrubbing and chemical absorption is that glycols are hygroscopic, meaning that they will absorb water by forming crystalline structures. This provides co-adsorption of H_2S , and CO_2 , and H_2O . Nonetheless, moisture pretreatment by refrigeration is preferred in order to minimize the burden on glycol regeneration. Glycols will also scrub halogenated hydrocarbons and ammonia, but they will react with ammonia to form unwanted reaction products. N_2 or O_2 may only slightly be removed, but it is likely to be insignificant.

Scrubbing with organic solvents has several other advantages over using water. Firstly, greater contaminant solubilization into glycols permits glycol systems to have smaller designs and lower circulation rates. Organic solvents are also anticorrosive, so pipework does not need to be made of stainless steel. Secondly, their low freezing point allows low temperature operation, which is better for absorption. In places with water shortages, they may additional gain support from the fact that no water or antifoaming agent is consumed.

Despite these benefits, physical solvents are more expensive for small-scale applications than pressurized water scrubbing or pressure swing adsorption. They also require a larger total energy demand, although this largely consists of the heat needed for solvent

regeneration. The electricity requirement tends to be lower than most other upgrading technologies. Physical solvent scrubbing can be energy-competitive if waste heat from another process is utilized. Similar to pressurized water scrubbing, maintenance costs are close to 2 – 3% of the investment cost. Maintenance includes occasional turnovers of the organic solvent, compressor lubricant, and any adsorbent used for preliminary H₂S removal.

Water Wash (WW)

Water wash is one of the most common and readily applicable purification systems where compounds can be physically dissolved into water. Water is commonly used due to low cost, low toxicity, and high availability. Integrating it to the wastewater treatment plant can also help with water availability as the water itself doesn't have to be pure to be used in the biogas treatment process and no pumping would be required as well.

CO₂ and H₂S preferentially dissolve into water compared to CH₄ due to lower partial pressure of methane. Carbon dioxide and hydrogen sulfide are 26 and 75 times, respectively, more soluble than methane in water¹. H₂S can also be selectively removed by water scrubbing because it is even more soluble in water than CO₂. However, the H₂S desorbed after contacting can result in fugitive emissions and odor problems. Pre-removal of H₂S is a more practical and environmentally friendly approach but is not required. Similar to pressure swing adsorption (PSA), water wash is also a popular process for gas treatment because of its ability to simultaneously remove many contaminants including ammonia, sulfur dioxide, chlorine, hydrogen chloride, hydrogen fluoride, aldehydes, organic acids, alcohol, silicon tetrachloride, silicon tetrafluoride, and siloxanes.

¹Solubilities in water: Carbon dioxide 8.2E-4 mole fraction at 15°C, hydrogen sulfide 2.335E-3 mole fraction at 15°C, methane 3.122E-5 mole fraction at 15°C.

A gaseous compound's dissolution into water is greater at higher pressures. When water scrubbing is used for CO₂ removal, the biogas is pressurized typically at 50 to 250 psi with a two-stage compressor, before entering the bottom of the column. These high pressures require less water in the process.

Absorber is the most important instrument in a water wash system. The absorber column typically contains a packed bed consisting of a high surface-area plastic media, allowing for efficient contact between the water and gas phases. The bed height and packing type determine the removal efficiency, while the bed diameter determines the gas throughput capacity. The CO₂-saturated water is continuously withdrawn from the bottom of the column and the cleaned gas exits from the top. The product gas is around 93 – 98% methane, but the process loses about 1 – 2% methane into the tail gas—more than most other systems. In an ideal system with 100% CO₂ absorption, at least 4% of the methane will also be dissolved into the water. The waste CO₂ and H₂S enriched water can be regenerated in a flash tank where the pressure is reduced, releasing the dissolved gases.

Again, due to CH₄'s low water solubility, CH₄ is released first and can be recirculated to another scrubbing column, effectively increasing the biogas CH₄ concentration. Air stripping the waste water may also be done to remove H₂S since H₂S may clog pipes in the regenerative system. However, air stripping introduces oxygen into the water which will desorb into the biogas, so this may not be suitable for applications where high methane concentrations are required. The treated waste water is then recycled into the scrubber unit. The exhaust gas can be treated by regenerative thermal oxidation or flameless oxidation to avoid SO₂ emissions. Figure 2.7 shows the design and fluid flow through a biogas regenerative water scrubber system.



Figure 2. 6: Biogas Water Scrubber System Design. Illustration Credit: (Hudde, 2010)

Even though flashing and stripping can reduce or free the dissolved CO_2 and other impurities, the system is incapable of completely regenerating the working water, so the water must be gradually replaced over time. Additionally, as more CO_2 is absorbed in the scrubbing column, its partial pressure decreases, making it harder to absorb more CO_2 . Thus, high water flows are needed to reach low CO_2 concentrations. Therefore, even with regeneration, water scrubbing requires a large amount of water—0.9 – 40 L discharged scrubbing water per Nm^3 of raw biogas processed (or 10% of the process water per hour) for regenerative scrubbing, and 100 – 233 L/Nm^3 for non-regenerative scrubbing (Persson, 2003). Water scrubbers are more efficient and cost-effective without regeneration, when a constant supply and discharge of water is possible, such as at a wastewater treatment facility. In fact, the first time a water scrubber was used to clean biogas in the US was at a WWTP in Modesto in the 1970s.

Another way to save cost and energy can be achieved by using secondary or tertiary treated wastewater as the scrubbing water. But the challenge remains that, it may also add microbial-related problems. The microorganisms present in the wastewater can create the risk of introducing pathogens into the gas stream, which can contaminate the gas transmission system and pose health hazards. However, a study by Vinnerås, Schönning, and Nordin found that natural gas contained low concentrations of spore-forming bacteria such as *Bacillus* spp., and that the densities of microorganisms found did not differ much

from what was found in biogas upgraded by wastewater scrubbing (Vinnerås, Schönning, & Nordin, 2006). Gas intoxication and explosions were more likely occur at a low biological concentrations, before ingesting a dose of pathogens high enough to cause an infection. The pumping cost can be saved and with regards to the possible issue of plugging by biological growth, the water scrubber should be internally and externally cleaned several times a year. The saving from pumping will have a larger impact than occasional cleaning.

Biogas water scrubbing, or water wash process is the most prevalent upgrading technology, as it is simple, robust, flexible, proven, and has relatively low investment and operational costs. It is best implemented in medium and large applications, with competitive pricing for larger projects, and especially for higher concentration H₂S streams. There are significant economies of scale for all the technologies investigated, the specific investment costs are similar for plants with a throughput capacity of 1500 Nm³ raw biogas per hour (950 cfm) or larger (Bauer, Hulteberg, Persson, & Tamm, 2013).

In order to minimize the methane slip from the water scrubber, the pressure is first decreased from 100-150 psi in absorber to around 2.5–3.5 bar (35-50 psi) in a flash column. The main share of absorbed methane, as well as a small share of the carbon dioxide, is released from the water and recirculated to the compressor and mixed with the raw biogas entering the scrubber.

However, water wash can be slightly less energy efficient than most other systems, typically requiring close to 0.3 kWh/Nm³ of cleaned gas. But as explained this limitation can be overcome by integrating it with waste water treatment plant. There are also limitations in H₂S removal. The pH of H₂S or CO₂ absorbed water will be lower and the tank and pipe will be prone to corrosion and thus would require to be made of PVC or stainless steel. Additionally, water scrubbers can be sensitive to environmental conditions such as temperature. Maintenance costs are typically 2 – 3% of the investment cost.

If the water consumption is an issue , a variant of conventional water scrubbers can be used. It is a high-pressure batch-wise water scrubber that uses pressures above 2,100 psi. It operates by first filling the scrubbing columns with compressed biogas then pressurized water is then pumped into the columns that displaces the gas. The water is afterwards purged and regenerated by a flash tank and a desorption column similar to a general water

wash system. The system produces a 92 – 95% methane gas and because of higher pressure the methane slip is higher in around 1 – 3%. Compared to conventional systems while it uses significantly less water (33.4 – 66.8 L/Nm³ of product gas) but consumes more energy (0.4 – 0.5 kWh/Nm³ raw biogas).

While batch wise scrubber uses high pressure another variation of conventional water scrubbers, rotary coil water scrubber commercially named as Biosling can be used at low pressure. It works by water and gas flowing through a rotating coiled tubing. Water is first fed into the outermost coil turn at 29 psi (2 bar). As the coils rotate, water columns are forced inward and compress the gas effectively increasing the pressure to 145 psi (10 bar). This results in efficient carbon dioxide absorption, producing a gas with 94% methane with about 1% methane slip. To increase the methane content further to 97%, the rotary coil can be equipped with a post-process conventional water column (Biosling AB, 2012). The Biosling is claimed to be more energy efficient than conventional water scrubbers, consuming only 0.26 – 0.44 kWh/Nm³ of product gas. Although the Biosling is commercially available, there are no full-scale commercial installations at this time.

Pressure Swing Adsorption (PSA)

Like other methods the goal of Pressure swing adsorption (PSA) is to separate carbon dioxide from methane. The process is performed by adsorption/desorption of carbon dioxide on zeolites or activated carbon at different pressure levels. The technology is very common in gas treatment industry as it is also effectively removes volatile organic compounds (VOC), nitrogen and oxygen from industrial gas streams. PSA requires varying pressure between 1 – 10 bar, but often 4 – 7 bar, and a temperature of 5 – 35 °C (Williams, Kaffka, & Oglesby, 2014). After the pressure is applied, CO₂ with other contaminants are adsorb onto the media. The remaining unadsorbed gas, mostly methane, is transferred out of the vessel. After the pressure is reduced in the vessel, the unwanted captured gases desorb and are ready to be sent in a different location. In most cases, multiple vessels are used in parallel to get a high production rate and better-quality gas that can improve energy efficiency.

Figure 2.8 shows a four-vessel pressure swing adsorption system using carbon molecular sieves, cycling between absorption and regeneration.

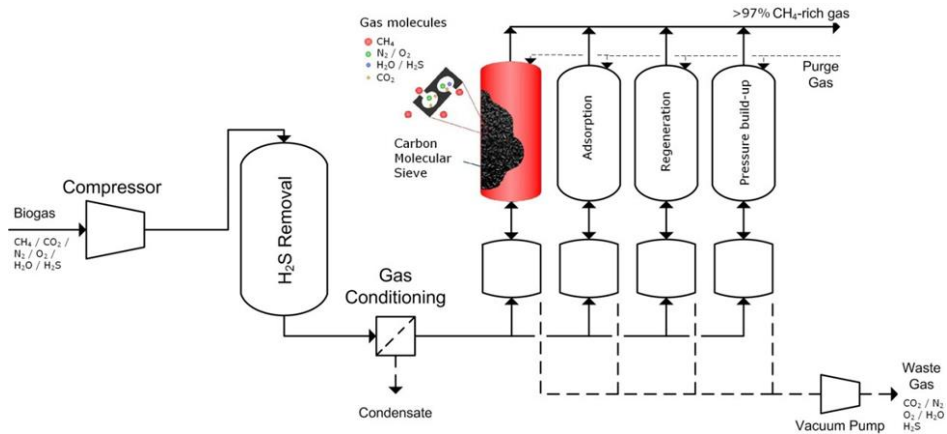

Figure 2. 7: Pressure Swing Adsorption Process Diagram. Source: (Zhao et al., 2010)

Pressure Swing Adsorption is also highly efficient in removing impurities from biogas. PSA can provide upgraded biogas with methane concentrations as high as 95-98%. The methane recovery rate can range from 60 to 80% which means the rest of methane leaves the system in the tail gas with the desorbed CO₂ (which would be 10-20% methane by volume). It's one of the disadvantages that the methane slip is higher than other typical recovery processes. Among other possibilities, the tail gas can be combusted to destroy the bypass methane for heat recovery.

On the other hand, the waste gas can be sent through another PSA cycle for additional methane recovery. By mixing the blowdown gas with the raw biogas, methane recovery can be increased by up to 5%. Carbon beds have an operating life of 4,000 to 8,000 hours but are longer at low H₂S levels. Thus, hydrogen sulfide pretreatment may be preferred. But if the pretreatment of H₂S is chosen, moisture content should be a concern since water can block the absorbent's micropore thus system performance can be reduced.

One of the advantages of installing PSA is that, a simple PSA can be cost-effective at small scale as low as 10 Nm³/h of raw biogas. Thus, PSA systems have also been used as a follow-up polishing step for other upgrading processes, using long (several hour) cycles to remove small fractions of CO₂. But the methane loss still would be an issue.

However, a PSA can be fast when variant of PSA - rapid cycle PSA (RPSA) is used, which operates at 5 – 20 times the cycle speed by using multi-port selector rotary valves and a multitude of smaller adsorption chambers. Rapid cycle PSA systems boast smaller sizes, lower capital costs, simple control interfaces, lower pressure drops, and higher throughputs. Overall, RPSA takes the shortest time comparing to similar recovery techniques (Torkkeli, 2003). However, their high speed comes at the cost of lower methane recovery. Their complexity also makes it difficult to personally perform maintenance, and valve wearing becomes more of an issue. Nevertheless, rapid cycle PSA systems have proven their efficacy with many successful full-scale operating projects. One of the largest suppliers of rapid cycle PSA technology is Xebec Adsorption Inc., which sells biogas purification with a capacity range from 150 to 5,000 Nm³/h (100 – 3000 cfm) of raw biogas (xebecinc.com). According to Xebec, their plant in Cincinnati, OH can upgrade biogas from a mere 20% to an impressive 98% (XEBEC, 2012). The plant has a capacity of 3270 Nm³/h or 2000 cfm.

Membrane Separation

Unlike other purification processes, membrane separation uses pressure and membrane instead of an absorbent solution. Membrane separation utilizes high gas pressures to create a large pressure differential across a nano porous membrane causing gas separation. The process can use several different mechanisms including molecular sieving (size exclusion), Knudsen diffusion (mean path difference), solution-diffusion (solubility difference), surface diffusion (polarity difference), and capillary condensation (adsorption). However, the permeation rate of different gasses can be different depending upon the membrane pore size (Figure 2.9).

Figure 2. 8: Gas Separation Membrane Permeation Rates. Source: (Suda & Haraya, 1997)

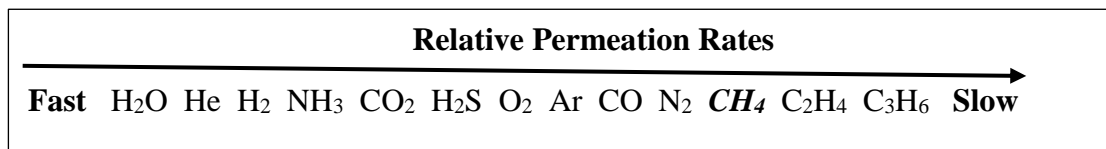

Contaminant or target molecules are forced through the membrane by pressurizing the feed gas side to somewhere between 100 – 600 psi (7 – 10 bar), depending upon the biomethane quality requirements as well as the design and manufacturer. The feed gas is passed across

the membrane at an optimal velocity to allow for optimal contaminant gas permeation and minimal methane permeation. After membrane treatment, the majority of carbon dioxide, water, hydrogen, and ammonia will pass through the membrane and be removed. The feed gas will retain most of the methane, with some hydrogen sulfide, nitrogen, and oxygen. Figure 2.10 (i) shows typical gas permeability through a membrane.

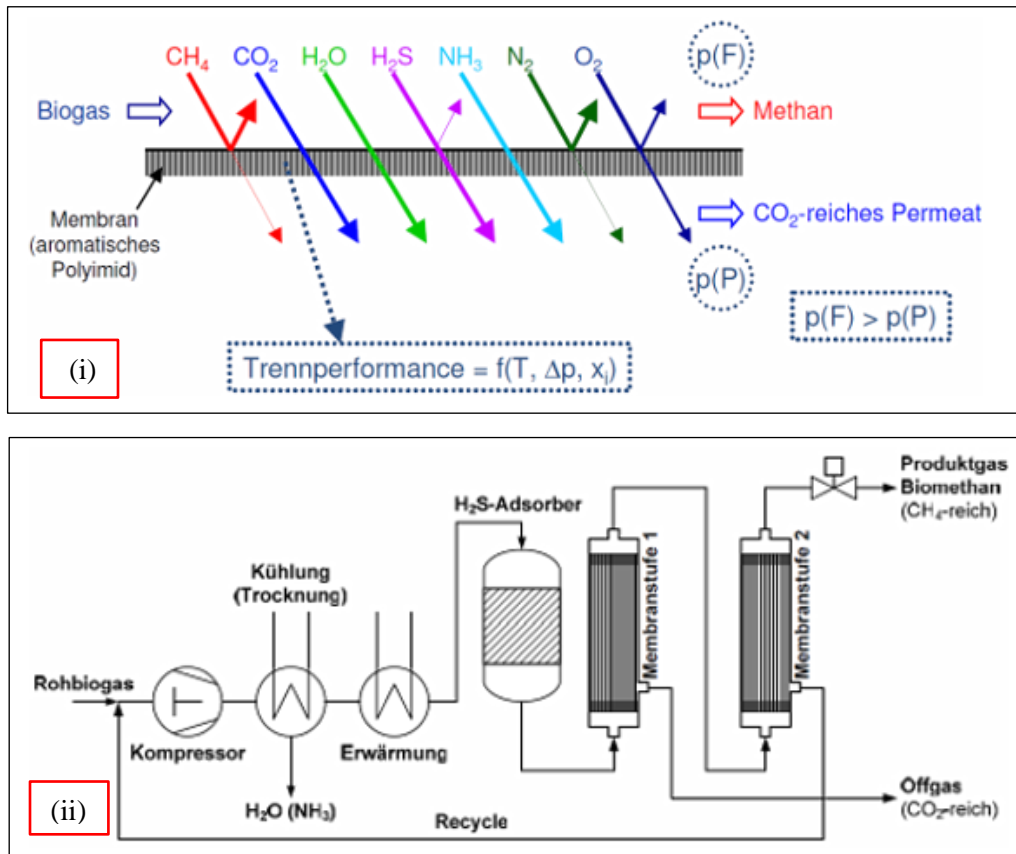

Figure 2. 9: (i) Schematic representation of the separation principle (ii) Two-stage process with recycle and a compressor [Raw biogas (Rohbiogas) enters the system from left]. Illustration Credit: (Harasek, 2006)

For membrane safety, biogas generally requires pretreatment to remove aggressive substances that can destroy the membrane material. The pretreatment is also necessary because the membrane separation does not remove H₂S or inert (e.g., O₂, N₂) very well.

The substances that can damage the membrane include water, hydrogen sulfide, ammonia, VOCs, siloxanes, particulates, and oil vapor. Water is removed to prevent condensation during compression, and hydrogen sulfide is removed since it is not sufficiently removed by membranes. Oils that are naturally present or picked up from the compressor should be removed to prevent membrane fouling. Ammonia can cause membrane swelling, while siloxanes and particles can physically damage the compressor and membrane structure.

The pretreatment has other disadvantages as well. Despite the use of gas pretreatment systems, the membranes can still suffer from plasticization, compaction, aging, competitive sorption, and fouling. Eventually, the membranes must be replaced. The membranes should be replaced in every 2-5 years.

Gas separation membranes are mostly constructed from bundled polymeric (e.g., polysulfone, polyimide, polydimethylsiloxane) hollow-fiber membrane or carbon membrane, as opposed to natural organic or sheet, for superior structural integrity and higher surface-area-to-volume ratios. In recent years carbon molecular sieve (CMS)-based membranes have attracted great attention because of their outstanding gas-separation performance (Wang, Ren, Zhang, Zhang, & Jin, 2018).

At present DMT Clear Gas Solutions LLC (dmt-cgs.com) provides their Carborex®MS technology to upgrade biogas using membrane separation. The entire system is built on a skid or in a container, which results in a small footprint and an easily transportable system. The spaghetti looking hollow fibers are used to create the membranes inside the Carborex®MS. The hollow fibers themselves are non-porous and made of polymers. DMT-CGS has their biggest plant in Ashland, KY, USA with a gas flow of 4000 cfm.

The hollow-fibers are bundled within small self-contained vessels, allowing for easy membrane unit replacement.

Figure 2. 10: Biogas Production to Supply Using High-Pressure Gas Separation Membrane Design at DMT-CGS

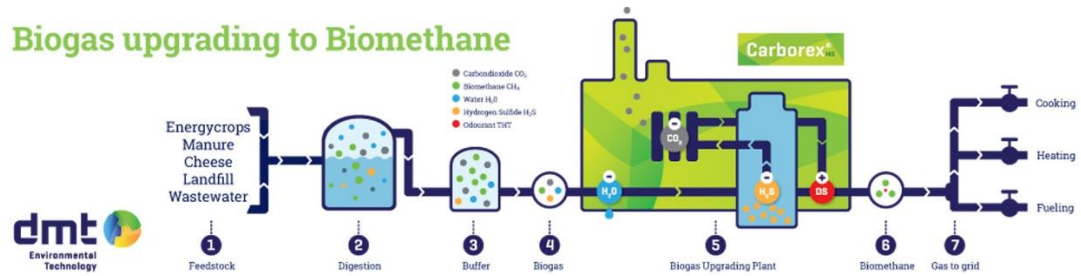

Illustration Credit: dmt-cgs.com (2018)

High-pressure gas separation systems are highly reliable, easy to operate, have a simple and compact plant design, and can also be used for gas dehydration. But unlike Pressure Swing, Membrane Separation has limitation due to permeation through the membrane and the separation is only reasonable at flow rates of more than 500 m³/h (300 cfm). There is a tradeoff between gas recovery and gas slip. If the pressure is increased the gas would better in quality but the gas slip would be higher (Coker, Freeman, & Fleming, 1998) Nevertheless, this process often has more methane slip (0.5 – 15%) than other upgrading technologies, which increases with higher product gas methane requirements.

In order to achieve higher methane content in the product, several stages can be used. For instance, biogas can be upgraded to around 92% methane content with a single membrane, or 96% with two or three membranes in series. According to DMT-CGS the membrane can upgrade methane to 98% using multi-stage process. However, the use of more membranes leads to higher methane loses and greater energy consumption. Membrane separation processes can have low or high energy consumption (0.18 – 0.77 kWh/Nm³), with the potential for low power consumption (< 0.22 kWh/Nm³) with highly selective membranes. Additionally, the gas liquid membrane technology can prevent typical problems like foaming and channeling by using a membrane between the gas-liquid interface.

Comparison Between Upgrading Technologies

Biogas Upgrading Process	Press. (psi)	T (°C)	Product CH ₄ Cont.	CH ₄ Slip	CH ₄ Recov.	Sulfur Pre-Treatment	Consumables
PSA	14 – 145	5 – 30	95 – 98%	1 – 3.5%	60 – 98.5%	Required	Adsorbent
Amine Absorp. (CHEM)	0 (< 150)	35 – 50	99%	0.04 – 0.1%	99.9%	Preferred / Required	Amine solution; Anti-fouling agent; Drying agent
Water Wash (WW)	100 – 300	20 – 40	93 – 98%	1 – 3%	82 – 99%	Not needed / Preferred	Water; Anti-fouling agent; Drying agent
Phy. Sol. Scrubbing (PHY)	58 – 116	10 – 20	95 – 98%	1.5 – 4%	87–99%	Not needed / Preferred	Physical solvent
Mem. Sep.	100 – 600	25 – 60	85 – 99%	0.5 – 20%	75– 99.5%	Preferred	Membranes

Table 2. 3: Comparison Between Biogas Upgrading Technologies. [Source: (Beil & Beyrich, 2013); (Severn Wye Energy Agency, 2013); (Starr, Gabarrell, Villalba, Talens, & Lombardi, 2012)]

MECHANICAL COMPONENTS OF WATER WASH

Absorber

Absorber is the most important mechanical component in a gas treatment system and there is still room for innovation to make it even more efficient. The primary function of an absorber is to increase the area of contact between the liquid and the gas phases to facilitate mass transfer. The process usually works by dividing the gas into small bubbles in a continuous liquid phase, spreading the liquid into films that flow through a continuous gas phase or forming the liquid into small drops in a continuous gas phase (Kohl & Nielsen, 1997). Depending on selected process the different absorbent solutions are chosen. It can be amine solution; glycol solution or water and the success of the process also depends on adapting proper absorber. The even distribution of liquid and gas in the absorption column

is another vital aspect that can be helpful in avoiding gas channeling, which causes a decrease in the removal efficiency of gas components (Hunter & Oyama, 2000).

For water wash, pressurized biogas is injected into the bottom of the absorption column and water is injected to the top of the column. The counterflow of gas and water is essential to minimize the energy consumption and methane loss as well as to maximize contact. After absorption the water leaves the absorber rich with carbon dioxide and other impurities while due to low partial pressure methane escapes and captured via an outflow system. The success of water wash system depends on water containing as much carbon dioxide as possible and as little methane as possible.

Packing materials and their orientation determines the efficiency of absorption. The packing material used in the gas absorption process can be either random packing or structured packing (Arachchige & Melaaen, 2012). There are several packing types available in the Aspen Plus process simulation tool. Random packing includes Pall ring, IMTP and Raschig rings while Structured packing includes Flexipac, Mellapak, Gempak and BX. In this study ceramic Raschig rings were used because they are easy to maintain. The other reason being water from waste water treatment plant has solids in it and can cause obstruction for water flow in structured packing. Sulzer is a multinational company working in more than 40 countries has innovative gas purification components including absorbers. The following figures would give an idea about their packing materials.



Figure 2. 11: Random Packing (left) and Mellapak Structured Packing (right). Source: sulzer.com

The height of the bed and the type of packing determines the efficiency of separation in the column, whereas the diameter determines the gas throughput capacity (Strigle, 1994). Therefore, a higher bed is better in cleaning biogas with lower methane concentration while a wider column is helpful in cleaning larger volume of biogas. While a bigger diameter is better for higher gas flow, it can be problematic if the flow is low due to minimum contact between gas and water. If the load is too low, the water will not be evenly distributed over the cross-section area and the biogas will be mixed with the water in a suboptimal way. The minimum load varies between 20% and 50% of the maximum capacity, depending on the design (Gamba & Pellegrini, 2013).

Flash

After the unwanted gasses are absorbed in the absorber, the waste CO₂ and H₂S enriched water can be regenerated in a flash tank where the pressure is reduced, releasing the dissolved gases. Depending on the pressure there is always methane slip that is absorbed by the water in the absorption column. To recover the methane the water is transported into a flash column. In the flash column, the pressure is decreased by around 30-50% to 30-50 psi from 100-150 psi in absorber. Due to different partial pressure, some of the carbon dioxide and most of the methane is released from the water and circulated back to the compressor for further absorption. At this point, methane concentration in water is very low and CO₂ concentration is very high. Although multiple flash units can be installed if the methane slip is high due to high pressure in absorber. Finally, the water that is transported to the stripper which will contain the main part of the carbon dioxide but typically less than 1% of the methane.

The pressure in the flash column is decreased to maintain the same methane slip if the methane concentration in the raw biogas increases. Because more methane and less carbon dioxide is transported with the water into the flash column, it changes the composition – more CH₄ and less CO₂ – in the flash column gas volume. If the pressure is kept constant, the partial pressure of methane will increase significantly resulting in higher solubility in the water. If the incoming raw biogas has a higher methane content, then there will be

higher methane slip which as well in return would require even lower pressure in flash to facilitate escaping of absorbed methane.

Unlike the absorber the flash column has no packing and is designed with a diameter wide enough to decrease the vertical speed of the water to such an extent that even small gas bubbles are able to rise instead of being dragged into the stripper. The top of the flash column should be designed so that water is not sucked into the gas going back to the compressor. The volume of this gas stream going back to the compressor is usually 20-30% of the incoming raw gas flow.

After removing most of the slipped methane from the water in the flash column, the carbon dioxide is released from the water in the stripper also known as desorption column. The water enters the top of the desorption column, while air is entering at the bottom. The pressure in stripper is kept at atmospheric level to facilitate the gas escaping especially carbon dioxide. The stripper is also filled with random packing to increase the contact surface between the air and the water. The water leaving the desorption column is almost free from carbon dioxide and is pumped back to absorber and it usually takes around 1-5 minutes for stripping depending on design and loading.

Compressor

As the Biogas waterwash process works based on supplied pressure and temperature, compressor is an essential element in the process. The process needs anywhere between 25-150 psi pressure based on water use and other parameters. The raw biogas passes through the compressor attaining a high pressure then it goes through the absorber. After the absorption of CO₂, H₂S and some methane, the water passes through the Flash. Because of low pressure in Flash, some of the carbon dioxide as well as the main part of the methane is released from the water and circulated back to the compressor.

Cooler

Gas compression increases temperature but the biogas waterwash process works best at low temperature. Temperature between 40-60 F is quite satisfactory for biogas waterwash and can be easily obtained most of time of the year in Midwest. With 2 absorbers, the

process uses 3 coolers to keep the water temperature at optimum level to provide better efficiency in biogas purification.

Stripper

Air stripping the waste water may also be done using the stripper unit to remove H_2S since H_2S may clog pipes in the regenerative system. Air stripping introduces oxygen into the water which will desorb into the biogas, so in this way the absorbed gasses can be taken out from the water and can be reused in the system. But, Flashing and air stripping are incapable of completely regenerating the working water, so the water must be gradually replaced over time. But there is another issue with air stripping that is H_2S will be partly oxidized to elementary sulfur and sulfuric acid (Ryckebosch, Drouillon, & Vervaeren, 2011). The rate of oxidation of H_2S in air saturated water has been studied and a clear correlation with both the temperature and the pH of the water has been shown (Millero, Hubinger, Fernandez, & Garnett, 1987). The rate of oxidation was increased around 3 times when the temperature was increased with 20 degrees and around 4 times when the pH was increased from 4 to 8 at the investigated conditions. The formation of acid in stripper would lower pH and can cause corrosion on various components, such as water pumps and pipes, especially if these are made of cast iron.

PHOSPHORUS RECOVERY AS STRUVITE

PHOSPHORUS RECOVERY

Importance of Phosphorus Recovery

Phosphorus recovery has been one of the biggest concerns in a WWTP. The primary concern is the environmental regulation the secondary reason being phosphorus is a limited natural resource. The Department of Natural Resources (DNR) has approved the phosphorus effluent level of 1 mg/L for waste water treatment plants under the Clean Water Act (Department of Natural Resources, 2013). The limitation is imposed under WPDES permits approved by DNR. The regulation reads as follows,

An effluent limitation equal to 1 mg/L total phosphorus as a monthly average shall apply to publicly owned treatment works and privately owned domestic sewage works subject to ch. NR 210 which discharge wastewater containing more than 150 pounds of total phosphorus per month, unless an alternative limitation is provided.

The common approach to recover phosphorous is by binding to the solid fraction of the digestate. It can be separated but because of the local chemical environment struvite forms almost immediately. Struvite is a magnesium mineral with ammonium and phosphate ($\text{MgNH}_4\text{PO}_4 \cdot 6\text{H}_2\text{O}$). It's only sparingly soluble in water, it precipitates both on pipe-work and as crystals in solution causing blockages which cannot be removed without significant and costly mechanical or chemical intervention (Cwm Harry Land Trust, 2013).

Chemical Formula of Struvite: $(\text{NH}_4)\text{MgPO}_4 \cdot 6(\text{H}_2\text{O})$

Table 2. 4 provides the chemical composition of struvite. As percent of weight almost 29% P_2O_5 is present in struvite.

Table 2. 4: Chemical Composition of Struvite

Component	Composition
<i>Magnesium</i>	9.90 % Mg as 16.42 % MgO
<i>Phosphorus</i>	12.62 % P as 28.92 % P ₂ O ₅
<i>Hydrogen</i>	4.93 % H as 44.05 % H ₂ O
<i>Nitrogen</i>	5.71 % N as 10.61 % (NH ₄) ₂ O
<i>Oxygen</i>	65.20 Oxygen

Significance of Struvite for MMSD

Milorganite, the famous fertilizer produced in Milwaukee Metropolitan Sewerage District (MMSD)'s Jones Island WWTP has a phosphorus content of 2.88% as P₂O₅ (Rehling & Truog, 1939) while commercially available Diammonium Phosphate (DAP) has 46% Phosphorus as P₂O₅ (IPNI, 2018). Struvite has 29% of P₂O₅ and can be a useful source for phosphorus. Besides, struvite breaks down biologically rather than chemically and it is therefore marketed as a slow-release fertilizer (Cwm Harry Land Trust, 2013).

Struvite formation has long been considered either as a curse or an opportunity, particularly by the waste water industry. (Münch, Benesovsky-Scott, Josey, & Barr, 2001).

It can be hugely detrimental, naturally forming a crystalline deposit to foul and clog pipe-work and thus needing costly and intensive remediation to remove (Doyle, Oldring, Churchley, Price, & Parsons, 2003).

It has also been heralded as a possible source of phosphates for agriculture, since stocks of rock phosphates are dwindling or are becoming too expensive to buy (Ueno & Fujii, 2001).

AVAILABLE PHOSPHORUS RECOVERY TECHNOLOGIES

Crystal Green

Crystal Green is the phosphorus recovery product commercialized by Ostara Nutrient Recovery Technologies Inc. Formulated with continuous release phosphorus, plus nitrogen and magnesium, Crystal Green is Root-Activated™, releasing in response to the organic acids produced by the roots with a healthy release of nutrients. Crystal Green gradually releases phosphorus according to root demand; safely supplying the soil solution with nutrients needed for optimal plant growth. This citrate soluble mode of action provides continuous nutrient release which minimizes phosphorus tie up in the soil, lowers the risk of leaching and runoff, and provides a season-long supply of phosphorus (crystalgreen.com, 2018).

Crystal Green is called 5-28-0 with 10% Mg because it has 5% Nitrogen, 28% Phosphorus, 0% Potassium and 10% Magnesium.

Struvite Recovery in Canada

Nutrient recovery from sludge dewatering reject water has been a subject of considerable research and development efforts in Europe, Japan and North America over the past decade (Jeanmaire 2001; Ueno and Fuji, 2001, Adnan et al., 2002). Since 1999, the University of British Columbia has been developing a proprietary struvite recovery process, which has recently been launched commercially by Ostara Nutrient Recovery Technologies Inc. To date the technology has been tested at pilot scale in four wastewater treatment plants: The City of Penticton, BC, the Lulu Island WWTP in Richmond, BC, the Gold Bar WWTP in Edmonton, AB, and the Nansemond WWTP in Suffolk, VA (Hampton Roads Sanitation District, HRSD). The technology has also been pilot tested for applications in greenhouse and animal waste treatment. The first full scale demonstration of this technology is adopted at the City of Edmonton Gold Bar WWTP after successful completion of a 6-month pilot study (AT Britton et al., 2007).

A pilot scale struvite recovery system was operated at the city of Edmonton’s Gold Bar WWTP for a period of approximately 6 months from March to November 2006. The objectives of this pilot demonstration were to demonstrate that the system could cost effectively recover 75% of soluble phosphate from the sludge lagoon supernatant. The pilot project made use of UBC’s proprietary reactor design described below and tested several combinations of magnesium and sodium hydroxide dosage rates to determine the range of possible conditions capable of meeting the treatment target, leading to an optimum economic operating regime. Figure 2.13 shows how such a system would work whereas Table 2.5 shows the removal efficiency. According to AT Britton et al., (2007) on average 71% phosphorus can be removed when the influent phosphorus concentration (as [PO₄-P]) was an average of 207 mg/L i.e. 69 mg/L of phosphorus (as [P]).

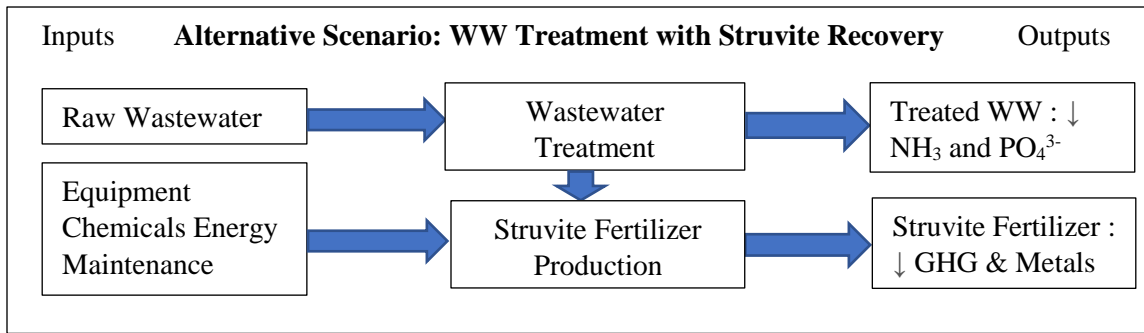

Figure 2. 12: Schematic Diagram of WW Treatment with Struvite Recovery (AT Britton et al., 2007)

Test No.	Feed flow (L/min)	Feed [NH ₄ -N] (mg/L)	Feed [PO ₄ -P] (mg/L)	Effluent pH	Effluent [NH ₄ -N] (mg/L)	Effluent [PO ₄ -P] (mg/L)	P removal (%)	N removal (%)
#1	2.4	810	180	7.90	610	28	80%	19%
#2	1.7	690	160	7.98	616	64	64%	11%
#3	1.9	780	150	7.85	717	50	81%	9%
#4	3.3	680	170	7.79	663	73	54%	3%
#5	2.9	720	200	7.87	710	61	67%	7%
#6	1.9	740	225	7.67	650	60	71%	12%
#7	2.3	790	230	7.83	600	61	65%	21%
#8	1.2	1226	340	7.80	676	70	82%	39%
Avg	2.2	805	207	7.84	655	58	71%	15%

Table 2.5: Summary of pilot scale struvite recovery test run results. Results are average for each test run. Source: (AT Britton et al., 2007)

For the supernatant curve, eq. (a) describes this polynomial curve, where pPs is the negative logarithm of the Ps. As a simple means of determining the saturation state of the supernatant being treated, a well-defined concept of Ps was used (K. N. Ohlinger, 1999). Ps designates how solubility changes with pH.

The solubility product, Ps is defined as,

$$Ps = \text{Struvite conditional solubility product and } Ps = [\text{Mg}^{2+}]_{\text{total}}[\text{NH}_4 - \text{N}]_{\text{total}}[\text{PO}_4 - \text{P}]_{\text{total}}$$

Where,

$$[\text{Mg}^{2+}]_{\text{total}} = \text{Total magnesium in sludge}$$

$$[\text{NH}_4 - \text{N}]_{\text{total}} = \text{Total nitrogen as } [\text{NH}_4\text{-N}] \text{ in sludge and}$$

$$[\text{PO}_4 - \text{P}]_{\text{total}} = \text{Total phosphorus as } [\text{PO}_4\text{-P}] \text{ in sludge}$$

This curve fits the data with a R^2 value of 0.993, indicating that this is an accurate representation of the equilibrium conditions in this case (A Britton et al., 2005)

$$pPs = -0.203pH^2 + 4.09pH - 11.76 \dots\dots\dots(a)$$

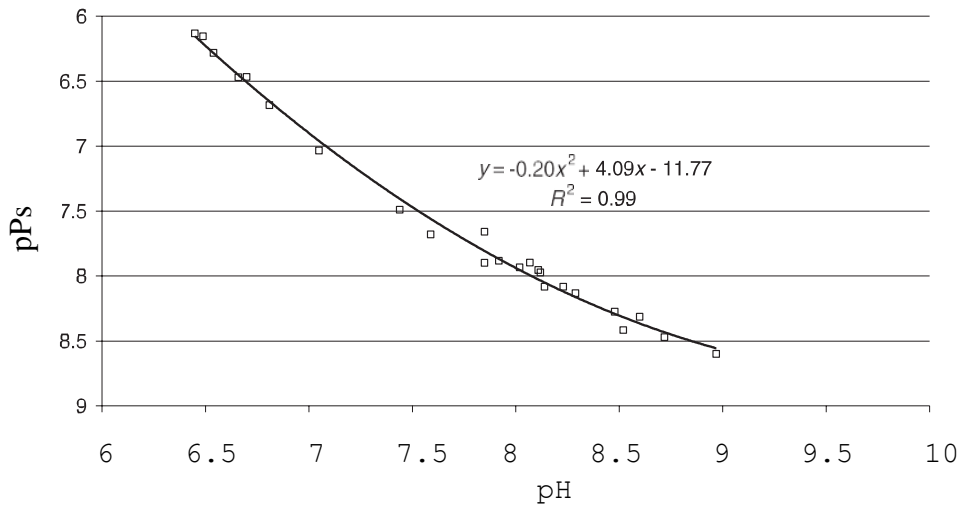

Figure 2. 13: Struvite pPs in digester supernatant and distilled water as a function of pH

During September 2 to December 13, 2001, overall phosphorus concentration was 7.8 - 18.8 mg/L as PO₄-P. But, initial data was not considered because high chemical dosages of both magnesium chloride and sodium hydroxide were necessary to induce the

crystallization of struvite. These early data are not presented here, because phosphate removal to <5 mg/L by struvite crystallization requires high operating cost (A Britton et al., 2005).

Later a method of transferring WAS from the gravity belt thickener was devised, thus allowing the transfer of much thicker sludge (approximately 5% solids). This practice allowed much more WAS to be transferred to the digester without hydraulic overloading, and the phosphate concentration could increase without high suspended solids in the supernatant. At this period, $PO_4\text{-P}$ ranged from 37 to 71 mg/L, whereas the $NH_4\text{-N}$ concentration ranged from 197 to 436 mg/L and the Mg concentration ranged from 11 to 35 mg/L (A Britton et al., 2005).

Struvite Recovery in US (HRSD, Virginia)

Nansemond Treatment Plant- HRSD is a 30 MGD facility that employs a 5-stage biological nutrient removal (BNR) process for N and P removal. Recovery Efficiency: 80-90% P and 10-40% $NH_3\text{-N}$. They considered both traditional “Ferric Addition” and “Ostara” (Latimer, Hanson, Khunjar, & Pitt, 2012).

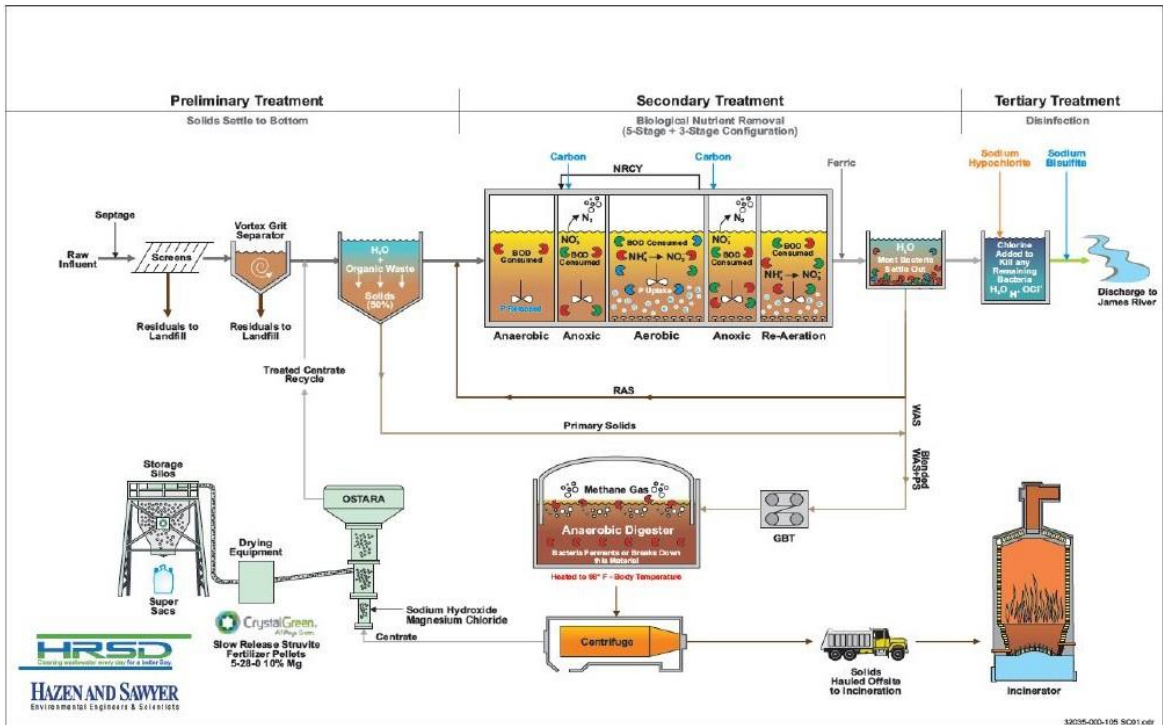

Figure 2. 14: Typical Layout of Nansemond Treatment Plant (HRSD), Virginia.

But they found Capital purchase option from Ostara was most profitable. The traditional ferric addition has similar efficiency but has a high maintenance cost (Latimer et al., 2012). The plant has been operating for two years and has produced around 1100 lbs. of struvite/day. Figure 2.16 shows that the plant was able to recover 90% of the phosphorus.

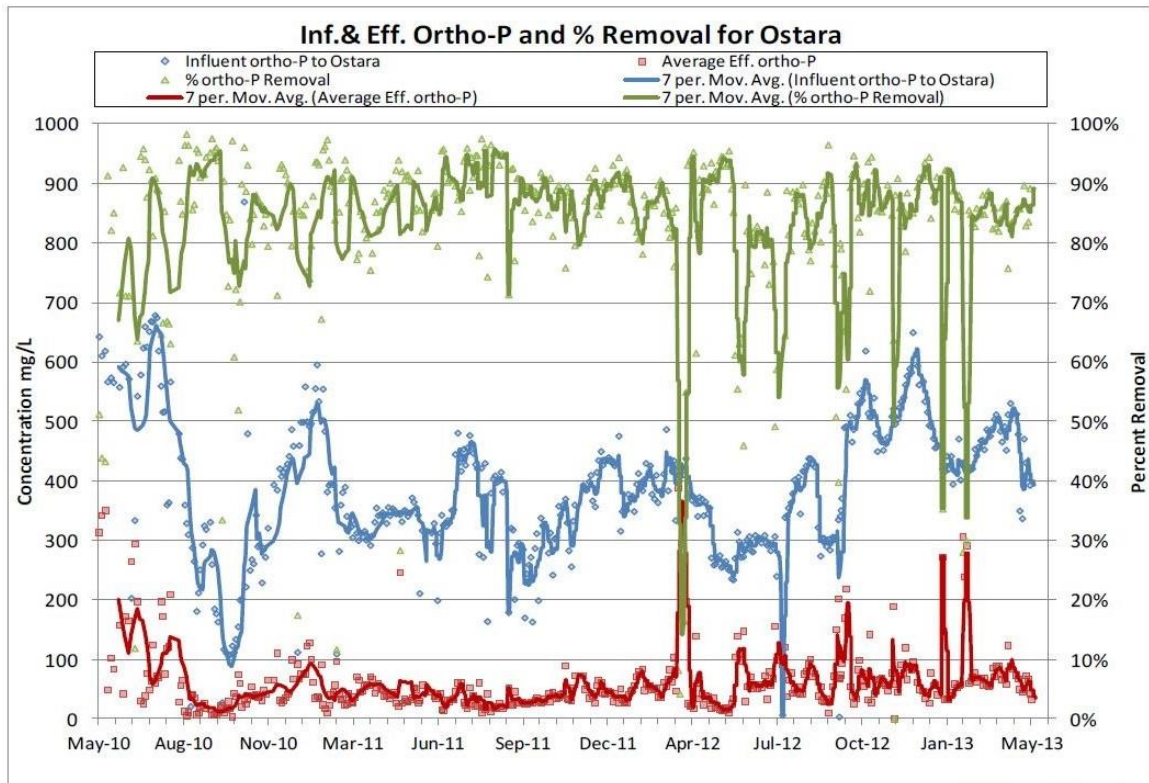

Figure 2. 15: Struvite Recovery at Nansemond Treatment Plant (HRSD), Virginia.

Source: Hazen and Sawyer

The plant was modified and upgraded to meet a total nitrogen limit of 8 mg/L year-round and 1 mg/L total phosphorus year-round. This includes new supplemental carbon feed facilities capable of utilizing methanol, ethanol, glycerin, MicroC, corn syrup, or acetic acid.

It was also upgraded to provide sidestream treatment of centrate i.e. cleaner water leaving after settlement, using the Ostara process and a backup ferric chloride addition system using an abandoned pretreatment structure to precipitate phosphorus and equalize the return stream (hazenandsawyer.com).

Struvite Recovery in UK

A £2m (\$2.8m) reactor that turns sewage into fertilizer has been installed by Thames Water at a plant in Berkshire (Tames Water, Slough). The nutrient-recovery facility takes waste water from the Slough Trading Estate and turns the phosphorus in it into crystalline fertilizer pellets. The company says it is the first of its kind in Europe and will save it £200,000 (\$280k) a year, which it will pass on to its 14 million customers (BBC.com).

About 150 tons a year of fertilizer will be produced and sold to farmers. Slough operates mesophilic anaerobic digestion and centrifuge dewatering. From the time that biological nutrient removal (BNR) for nitrogen and phosphorus became operational problems of struvite ($Mg(NH_4)PO_4 \cdot 6H_2O$) scaling in the pipeline were experienced. BNR works well at Slough because of the enormous amounts of soluble carbon from the confectionary companies on the industrial estate; BNR also works well at Reading, another recovery plant in UK because of the soluble carbon from a large brewery. At most other works, supplemental C is needed. When the surplus activated sludge becomes anaerobic in the digester, the P is released from the biomass (Evans & Lane, 2006).

CHAPTER III: EXPERIMENTAL MODELING AND CALCULATION

ASPEN PLUS SIMULATION OF BIOGAS WATERWASH

Aspen Plus is a simulation software used in oil and gas refinery as well as in pharmaceutical industry developed by Aspen Technologies. The physical property selection for modeling is a very important step in successful prediction of methane recovery. Among many models, the following thermodynamic models were tested: UNIQUAC (with ideal gas and Henry's Law), NRTL (non-random-two-liquid/ with ideal gas and Henry's Law), NRTL-RK (non-random two- liquid/Redlich–Kwong equation of state with Henry's law), UNIQUAC-RK (UNIQUAC/Redlich–Kwong equation of state with Henry's Law); ELECNRTL (the electrolytic non-random two liquids thermodynamic model with the Redlich–Kwong equation of state for aqueous and mixed solvent applications Henry's law) (Aspen Physical Property System 2010; Cozma et al. 2013). The success or predictability of a model depends on how well it can consider the variables like temperature and pressure as well as the mixture ratio and absorber internal setup. The selection of the models is supported by those parameters that are necessary to describe the gas solubility.

The Electrolyte-NRTL activity coefficient model meaning ELECNRTL works best for simulations with electrolytes. ELECNRTL calculates liquid phase properties from the Electrolyte-NRTL activity coefficient model. Vapor phase properties are calculated from the Redlich-Kwong equation of state (Aspen Tech, 1999). ELECNRTL can represent aqueous and aqueous/organic electrolyte systems over the entire range of electrolyte concentrations with a single set of binary interaction parameters. In the absence of electrolytes, the model reduces to the standard NRTL model. Aspen Plus contains a databank of binary interaction parameters between water and over 600 electrolyte ion pairs. The ELECNRTL model works well for biogas water wash because the process does produce acid solution or hydrogen ions. But the UNIQUAC model or Universal Quasi Chemical model considers independent central and local molecule or lattice formation, which does not fit for an acid solution such as biogas water wash.

The importance of gas–water relationship in environmental protection, geological science, or biological field is immense and several experimental measurements have been made by different authors on the solubility of binary systems of CO₂–water, methane–water, H₂S–water, nitrogen–water, and oxygen–water, over a wide ranges of pressures and temperatures. Based on this knowledge and different theoretical models the solubility of gases in pure water has been developed (Cozma et al. 2013).

Understanding the different components of biogas waster wash is essential in modeling. The previous analysis on related components can help us selecting appropriate model. Based on this analysis, the most relevant data were selected for each binary system (carbon dioxide–water, methane–water, H₂S–water, nitrogen–water, and oxygen–water) and compared with findings of (Cozma et al. 2013). The results are plotted in Figure 3.1.

To understand the results, the following aspects were considered,

- Data calculated from Figure 3.1a were compared with experimental data of (Lide, 2003);
- The solubility of CH₄ in water is calculated using experimental data of (Antonin Chapoy, Mohammadi, Richon, & Tohidi, 2004) and (A. Chapoy, 2004) and compared with experimental data of (Mao et al., 2011) and (Stoessel & Byrne, 1982); the compilation of the last two references is plotted in the same line (Fig. 3.1b).

Considering the results from Fig. 3.1, the following aspects were noted (Cozma et al., 2014):

- Results from UNIQUAC and NRTL models *did not* show a good agreement with the experimental CO₂ solubility for higher pressures (above 10 bars);
- NRTL-RK, UNIQ-RK, and ELECNRTL showed a good agreement with experimental data in all conditions presented.

Based on the finding, ELECNRTL, NRTL and UNIQUAC methods are proper for simulations pressure up to 10 bars without including the critical region, as stated by Carlson (1996). Since ELECNRTL demonstrates a better comparability of physical properties for methane, carbon dioxide and H₂S in water this thesis used ELECNRTL property model for further analysis.

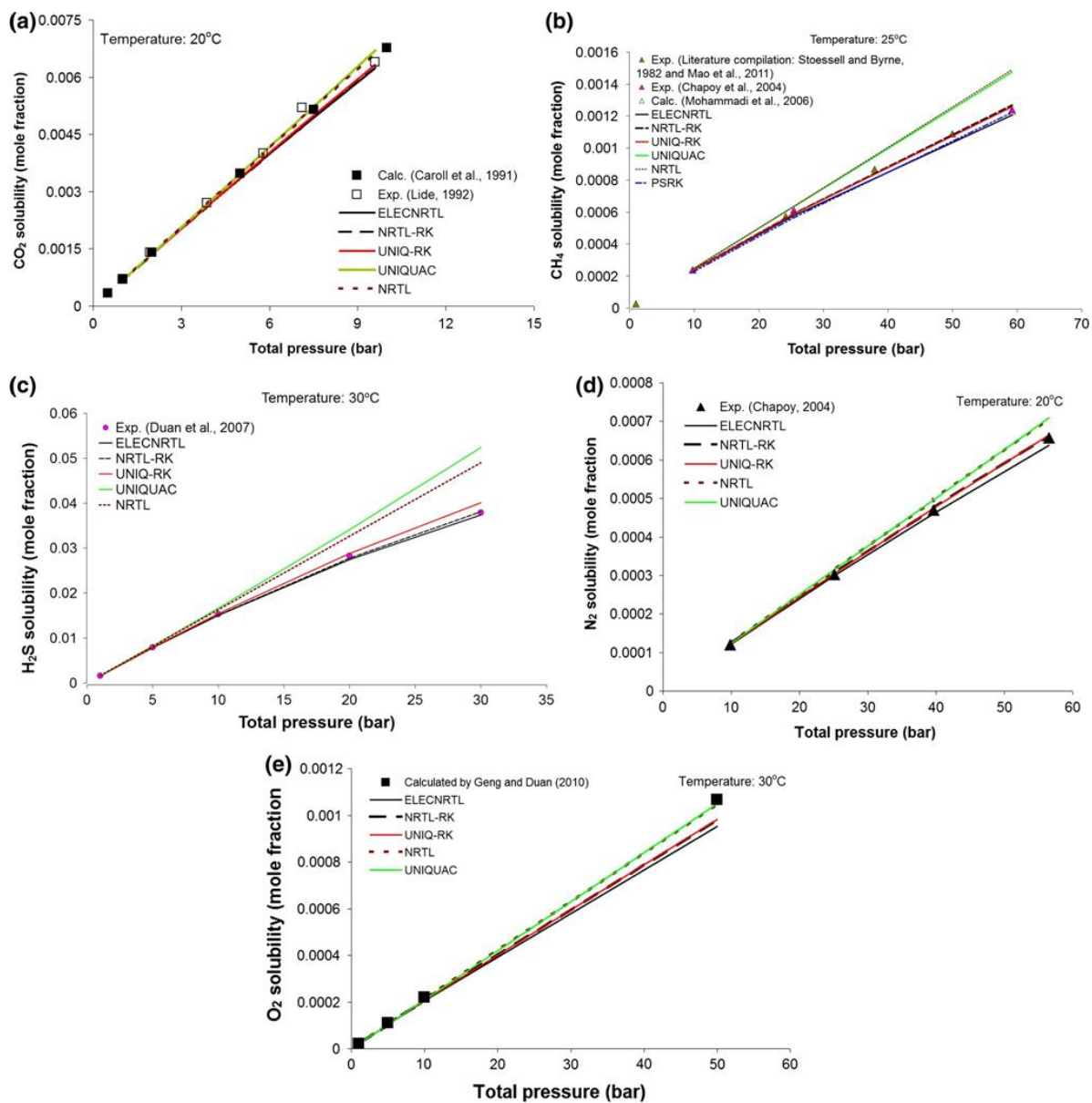

Figure 3. 1: Solubility of biogas components in water: (a) CO₂, (b) CH₄, (c) H₂S, (d) N₂, (e) O₂ (adapted upon Cozma et al. 2013; reproduced from Environmental Engineering and Management Journal) (Mao et al. 2011)

RESULTS OF SIMULATION

Absorption is a complex process and depends on many factors. Increasing the number of equilibrium stages favors the absorption rate in water. More CO₂ is dissolved and therefore higher percentage of methane is obtained. The flow diagram has two absorber connected in series with 2 flashes to recover slipped CH₄ and at the end of the system a stripper to strip out all the dissolved gasses from water so that the water can be recirculated in the system. WWTP integrated system will not need a stripper as recirculation is unnecessary.

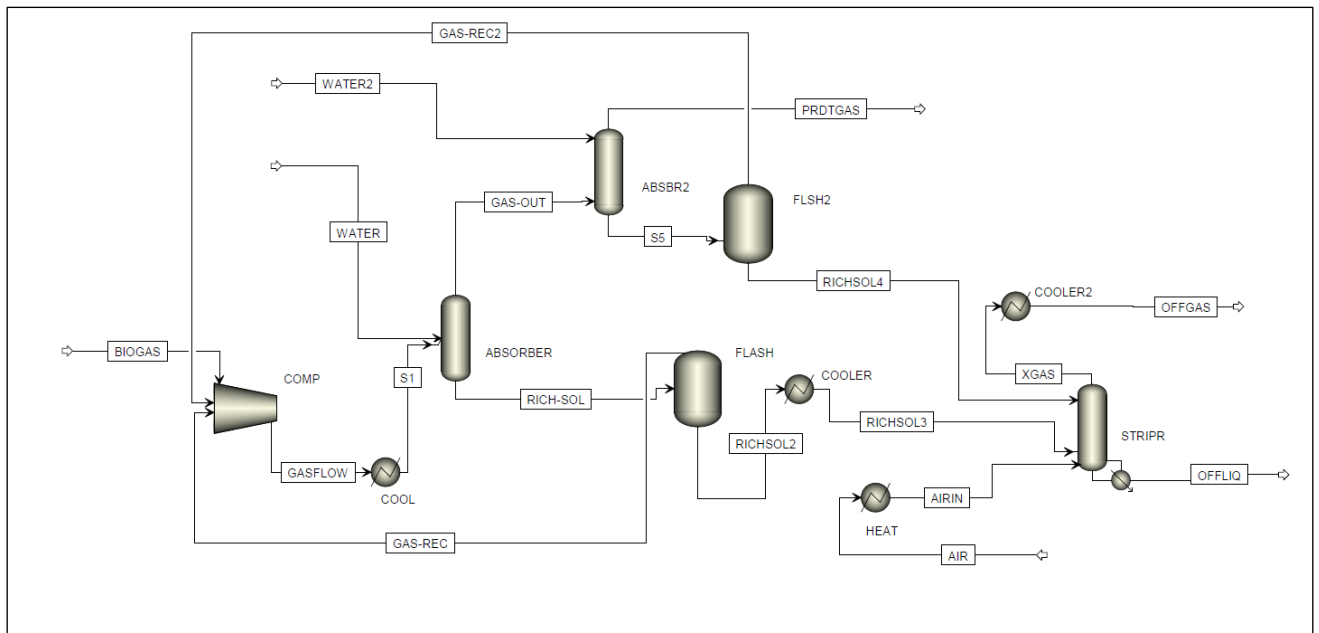

Figure 3. 2: ASPEN PLUS Flow Diagram with two absorbers.

Designing the absorbers in Aspen Plus modeling is sophisticated and precise sizing of packing materials and column diameter is necessary. Figure 3.3 and 3.4 shows the internal features of column 1 and 2 used in a pilot scale or for the gas flow of 20 cfm at 45psi.

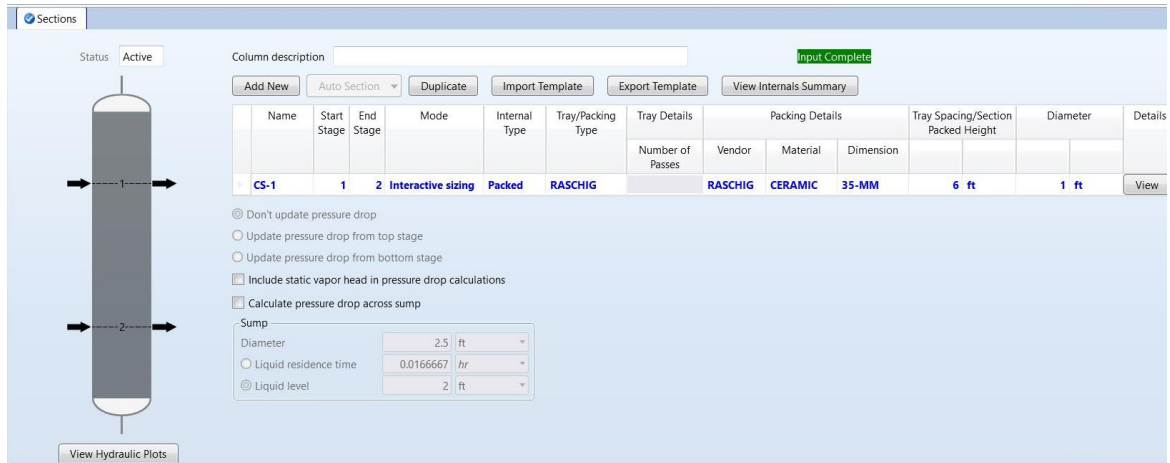

Figure 3. 3: Column Internal for absorber 1.

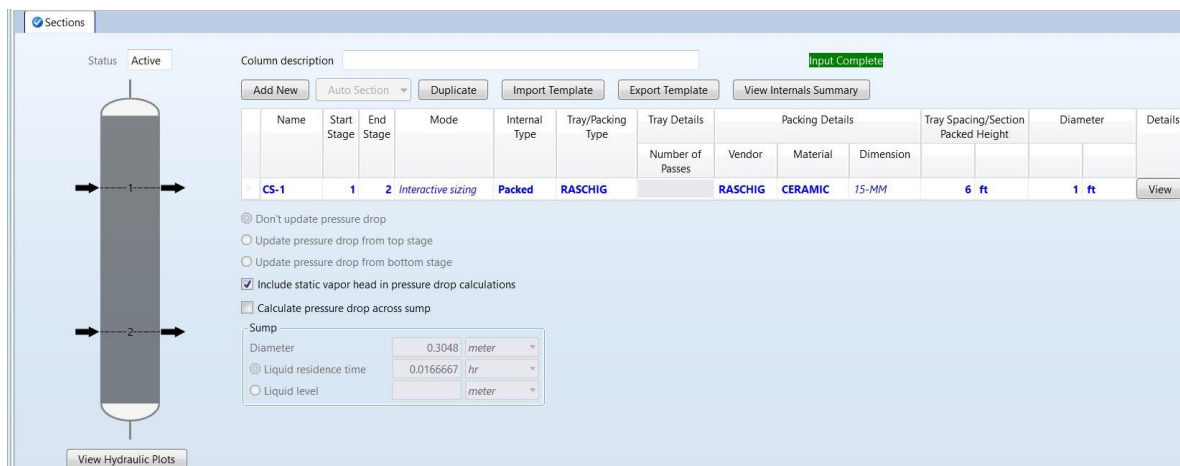

Figure 3. 4: Column Internal for absorber 2.

Another important consideration is flooding of absorber columns due to unfitting pressure or flow of gas and water. To avoid flooding, the height and diameter along with flow must be adjusted. The pilot simulation shows satisfactory hydraulic plots for both absorber column 1 and 2. Hydraulic plots are shown in figure 3.5 and 3.6.

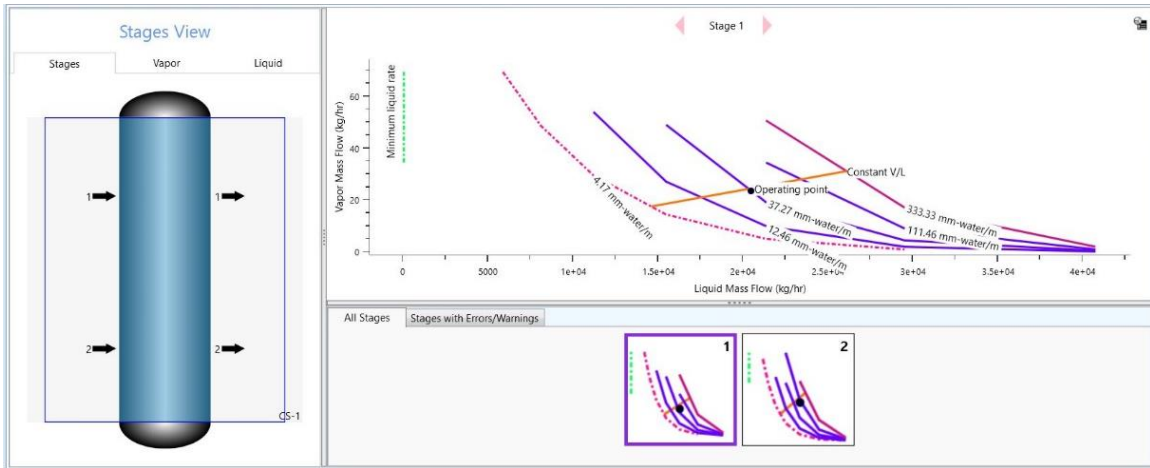

Figure 3. 5: Hydraulic Plot for Absorber Column 1.

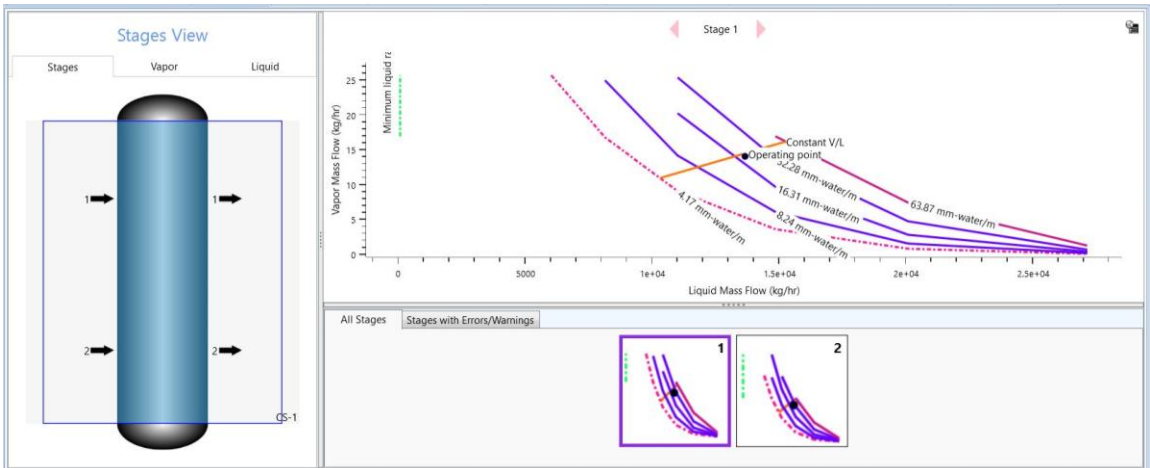

Figure 3. 6: Hydraulic Plot for Absorber Column 2.

The properties of the columns for the pilot scale have been summarized in table 3.1. The water flow in both columns is different as it provides a better methane recovery. As the absorbers are connected in series in the pilot study, the CO₂ concentration is higher in absorber 1 than in absorber 2. After absorption in column 1 most of the carbon dioxide is dissolved in water and only a small fraction is left to be absorbed in absorber 2. The simulation results show that for 150 psi pressure and water to gas ratio of 1 to 4, 91% methane is recovered in absorber 1 and with the help of second absorber the recovery rate can be raised to 97.7%.

Input

<i>Characters</i>	Absorber1	Absorber 2		Cooler	Compressor	Gas Flow
<i>Water Flow</i>	12 cfm	8 cfm		60F	45 psi	20 cfm
<i>Diameter</i>	12 in	12 in				
<i>Stages</i>	2	2				
<i>Internal Type</i>	Packed	Packed				
<i>Dimension</i>	35 mm	15 mm				
<i>Section</i>	6ft	6ft				
<i>Packed Ht.</i>						

Table 3. 1: Summary of Simulation Input for Pilot Scale

Result of Simulation for Pilot Scale

<i>Component</i>	<i>Off Gas</i>			<i>Off Water</i>		
	CH ₄	H ₂ O	H ₂ S	H ₂ O	CO ₂	CH ₄
<i>Amount</i>	98%	0.6%	0.65%	99.99%	~0%	~0%

Table 3. 2: Pilot Scale simulation data at 60°F Temperature and 45 psi pressure

2 ABS|45 PSI|GAS 90F|WATER FR: 12 & 8 CFM

WATER FLOW RATE (CFM)	Biogas (cfm)	Water Temp (F)	Methane PDRTGAS(%)	Methane Loss (%)
12 AND 8	20	40	98.8	0.55
12 AND 8	20	60	98	0.55
12 AND 8	20	70	97.3	0.55
12 AND 8	20	80	96.3	0.55

Table 3. 3: Simulation result for Pilot of Biogas water wash at varying temperature

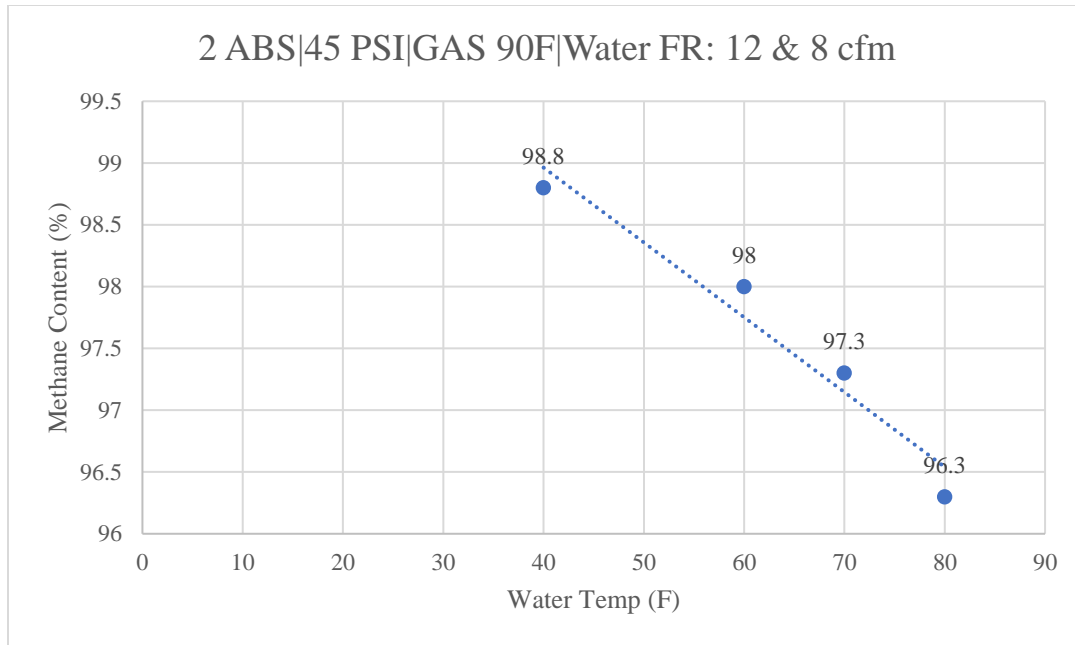

Figure 3. 7: Pilot Scale Biogas water wash simulation result at varying temperature
Result of Simulation for Full Scale

2 ABS|45 PSI, F-20 PSI|GAS 90F|Water FR: 150 & 100 cfm

Water Flow (cfm)	Biogas (cfm)	Water Temp (F)	Methane PDRTGAS(%)	Methane Loss (%)
150 and 100	250	40	98.8	5.20
150 and 100	250	60	98	5.21
150 and 100	250	70	97.3	5.22
150 and 100	250	80	96.3	5.24

Table 3. 4: Full Scale Biogas simulation result at varying temperature at 45psi

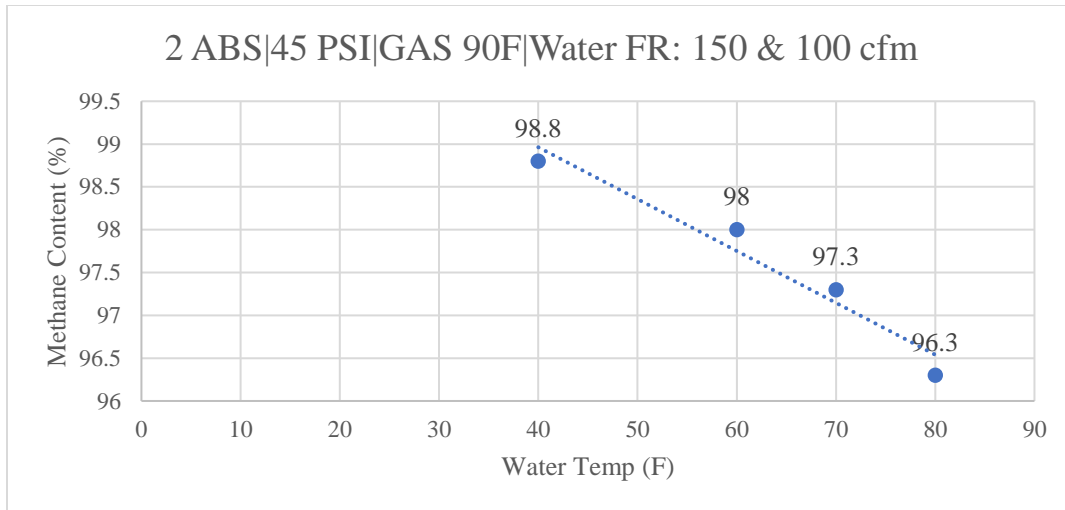

Figure 3. 8: Full Scale Biogas simulation result at varying temperature at 45psi

2 ABS A: 150 PSI, F: 60 PSI GAS 90F, 60F-COOLER Water FR: 38 & 25 cfm				
Water Flow (cfm)	Biogas (cfm)	Water Temp (F)	Methane PDRTGAS(%)	Methane Loss (%)
38 and 25	250	40	98.7	2.94
38 and 25	250	60	97.6	2.98
38 and 25	250	70	96.6	3.01
38 and 25	250	80	95.3	3.10

Table 3. 5: Full Scale Biogas simulation result at varying temperature at 150psi

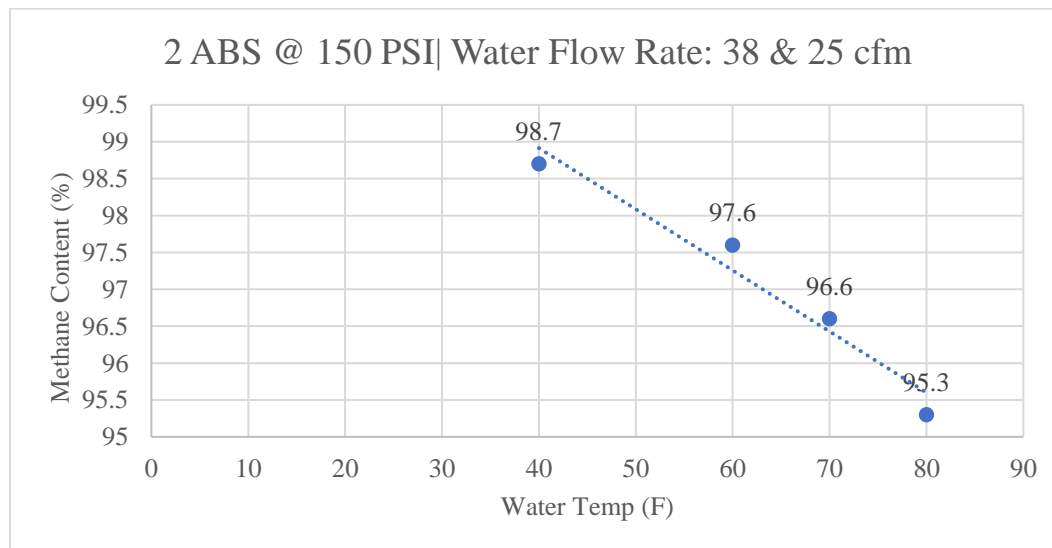

Figure 3. 9: Full Scale Biogas simulation result at varying temperature at 150psi

As shown in Table 3.4 and 3.5, less water is needed to achieve the methane content over 95% under higher temperature. For the pilot project, with 45 psi pressure 20 cfm water can treat 20 cfm gas flow. The number of absorbers was increased to two in series to provide satisfactory result. The pressure in the Flash has been reduced to half. Only 20 psi flash pressure has been applied when the absorber pressure is 45 psi. The 6 ft packed column, 2 stage ceramic absorber was chosen for simulation. There is no flooding issue in the absorber. As the tables 3.3 and 3.4 show with sufficient water flow, the methane content can be satisfactory (up to 98.8%) but the absorber has to be designed accordingly. As previously discussed ELECNRTL model has been used to run the simulation. Temperature plays a significant role as seen from the graphical representation in figure 3.7, 3.8 and 3.9. The methane content increased from 95% to 98% because of the change in temperature from 40°F to 80°F (Fig. 3.9). The colder climate in Midwest can facilitate the gas purification in water wash approach.

CALCULATION FOR PHOSPHORUS RECOVERY

MMSD treats 68.2 billion gallons of waste water every year (Don, 2017) or about 180 million gallons every day. Jones Island treats a larger share of it (about 62-220 MGD depending on the season).

Based on the data provided by MMSD [Figure 3.10(a)] (from May 2017 to April 2018) the average influent phosphorus concentration was **3.5 mg/L**. But as advised in the study of Britton (A Britton et al., 2005) the desired P-PO₄ concentration is 50-70 mg/L for struvite recovery to be economically feasible. To obtain such a high phosphorus concentration, a waste activated sludge gravity thickener is necessary.

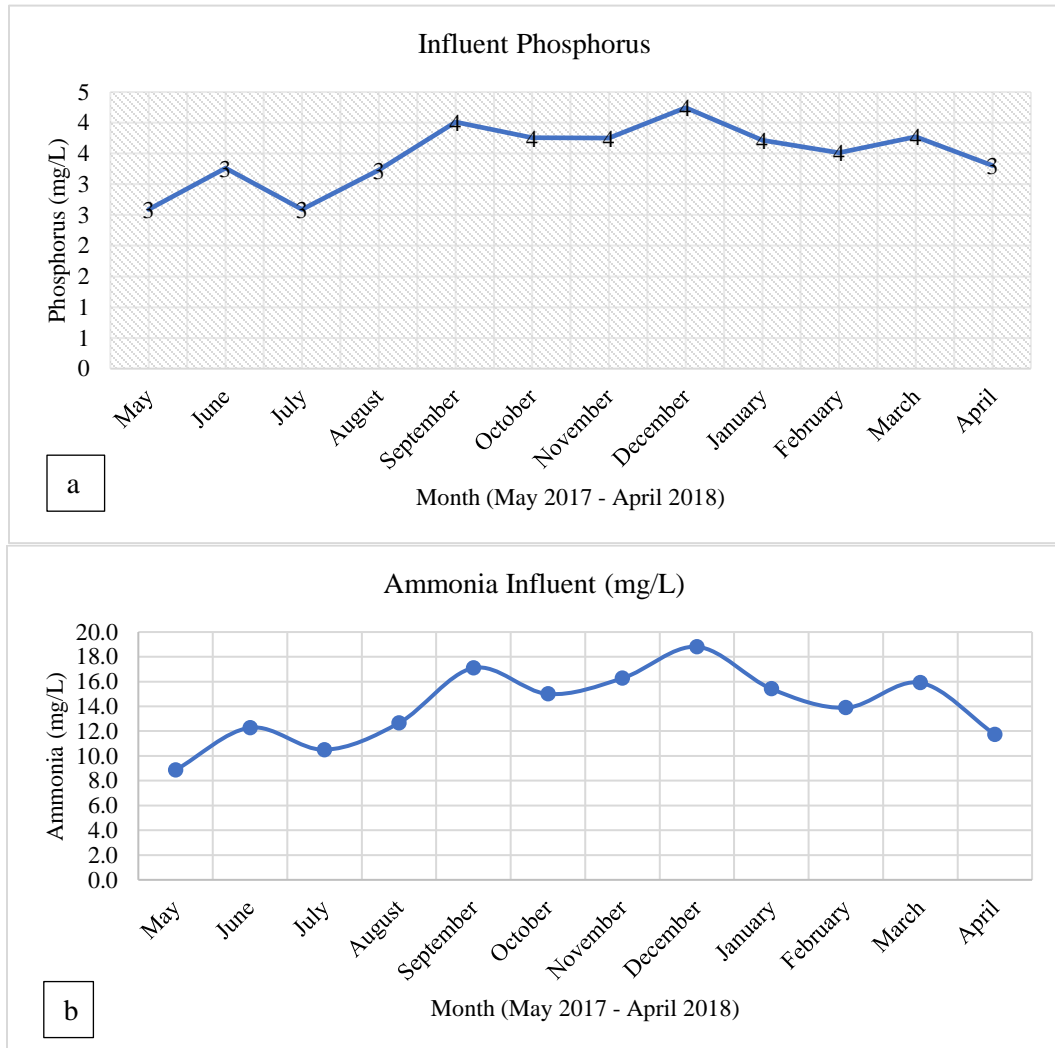

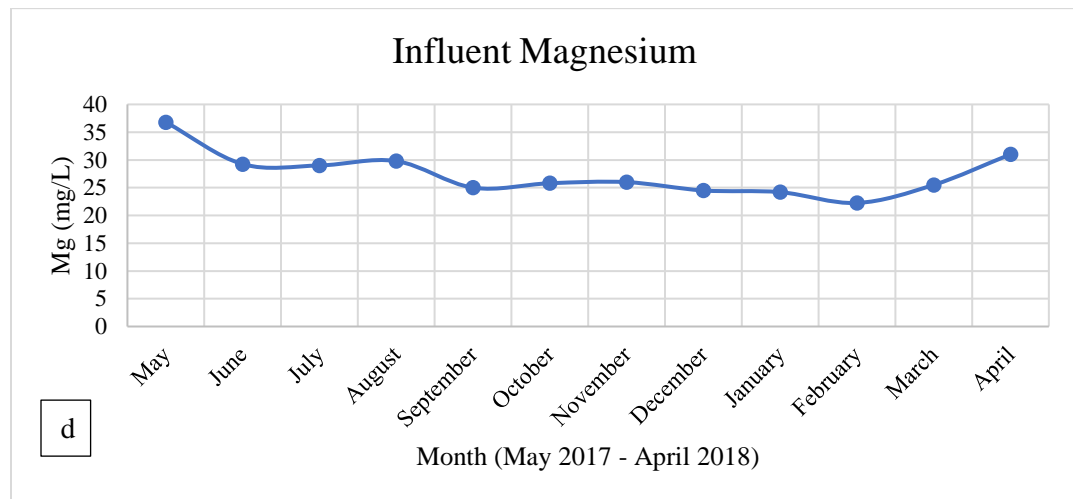
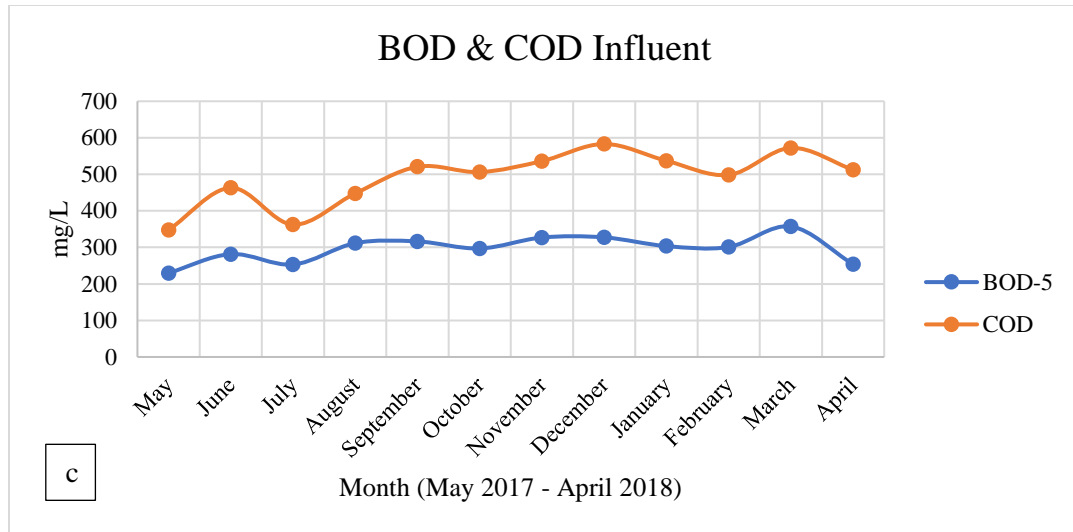

Figure 3. 10: MMSD’s Jones Island waste water influent data for a. phosphorus b. Ammonia c. BOD & COD and d. Magnesium

BOD and COD have significant impact in enhanced biological phosphorus removal but it’s magnesium that plays a central role in recovering phosphorus as struvite. As figure 3.10 (c) and (d) shows BOD of 300 mg/L and magnesium of 25 mg/L is present in influent of Jones Island WWTP. A much higher magnesium concentration is necessary to recover struvite at high rate. A theoretical calculation at the end of this chapter will discuss required magnesium addition.

After concentrating the phosphorus to 50-70 mg/L the pH has to be raised from around 7.0 to 8.0-9.0. In addition to a higher pH, magnesium also has to be added to get maximum struvite recovery. Up to 96% of the orthophosphate can be recovered this way. (Nelson, Mikkelsen, & Hesterberg, 2003)

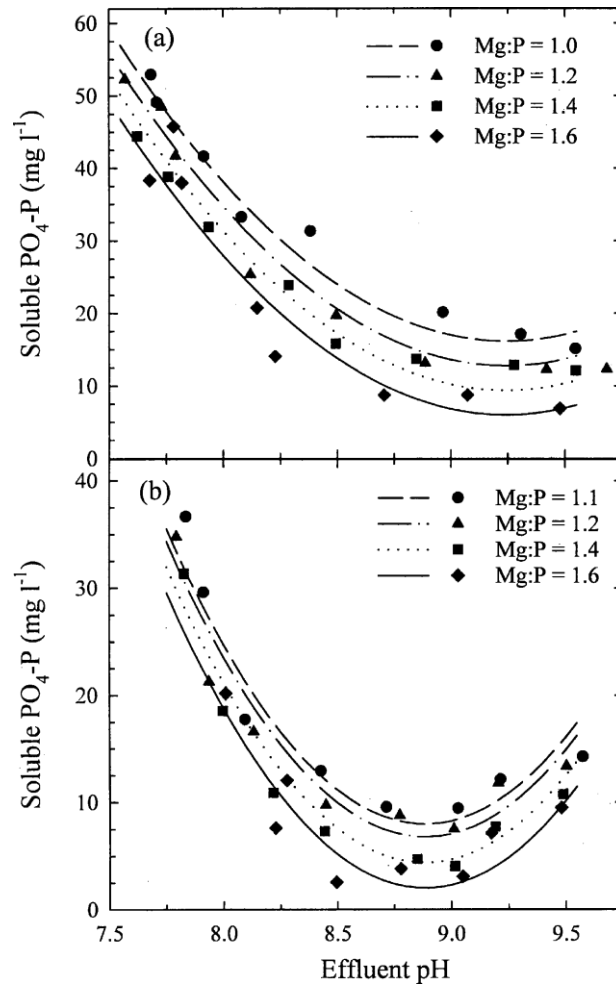

Figure 3. 11: Dissolved PO₄-P concentrations in anaerobic effluent solutions from the LW lagoon (a) and RM lagoon (b) after equilibrating for 24 h and forming struvite. Curves are predicted PO₄-P concentrations using multiple linear regression.

Figure 3.11 shows the struvite recovery at different pH when the precipitation occurs for (a) 25 mins and (b) 24 hours. The results suggest that soluble magnesium is only 2 mg/L and 5 mg/L when kept for 25 mins. Most of the precipitation occurs in the first half hour and after that it becomes significantly slower and has minimal contribution in overall phosphorus recovery.

A simplified theoretical calculation is presented based on MMSD provided data and an average flow of 100 MGD. The calculation explores the potential struvite recovery and magnesium dose requirement. The calculation also addresses the concentration of CO₂ in the sludge obtained from water wash process.

Calculation

a. Phosphorus

Flow = 100 MGD [For calculation purpose 100 MGD has been selected]

Inflow total phosphorus = 3.5 mg/L (Figure 3.10a)

Calculation Based on (Wisconsin DNR, 2009)

$$\begin{aligned} \text{Phosphorus (lb./day)} &= \text{Flow (MGD)} * \text{Inflow P (mg/L)} * 8.34 \text{ lb./MG/mg/L} \\ &= 100 * 3.5 * 8.34 \\ &= 2919 \sim 3000 \text{ lbs./day} \end{aligned}$$

b. MgO dose

Inflow = 100 MGD

Mg concentration = 30 mg/L (Figure 3.10d)

To obtain satisfactory level of struvite precipitation, Magnesium-Phosphorus molar ratio, Mg:P has to be 1.4:1 to 1.6:1 (Fig. 3.11)

Since, Magnesium doesn't coagulate, additional MgO will be necessary. To achieve a profitable struvite precipitation, phosphorus concentration should be over 70 mg/L. For a 90 mg/L of phosphorus loading,

$$\text{Mg required} = (1.6) * (90/30) * 24 = 115 \text{ mg/L}$$

The influent has 30 mg/L of Mg, additional Mg required = 85 mg/L of Mg

$$\text{Required MgO dose: } (85/24) * 40 = \mathbf{141 \text{ mg/L}}$$

c. Ammonia

The N:P in struvite = 0.45 (0.45 lb. of Nitrogen is required for 1 lb. of P) Source: Wis. DNR (Certification, 2009)

According to Fig 100b Ammonia in waste water = 15 mg/L or 12.3 mg/L of Nitrogen

$$\text{Nitrogen (lb./day)} = 100 * 12.3 * 8.34$$

= 10250 lb./day which is 7.8 times of the required nitrogen.

d. CO₂ from biogas water wash

At a temperature of 40°C and pressure of 87 psi for a full-scale biogas purification unit

If water: gas = 1:4 then methane content can be achieved as high as 96.2% when 2 absorbers are added with two flashes. Flash Pressure is 35 psi.

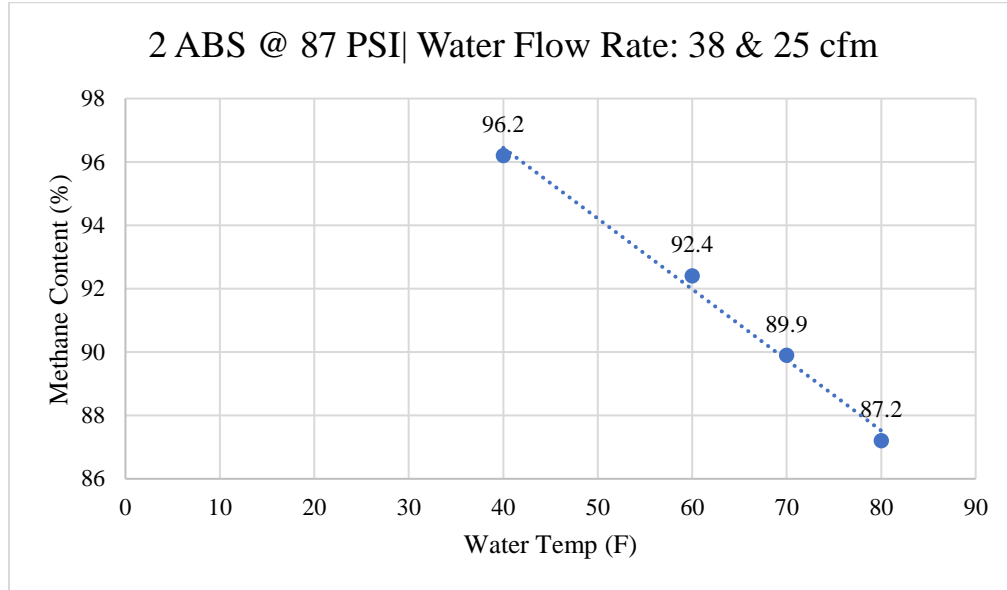

Figure 3. 12: Biogas Water wash at 87 psi with varying temperature [Aspen Plus Modeling]

For each full-scale plant

Based on Figure 3.8 water needed,

= 63 cfm water or 2.5 MGD

Based on this biogas rate, the daily CO₂ absorption = 8.3 tons/day.

And this would correspond to a [CO₂] level = 2,942 mg/L

MMSD has 8 full scale gas delivery system which would provide 66.4 tons of CO₂/day

And after mixing with 100 MGD water the [CO₂] level = **588 mg/L**

This dissolved CO₂ would lower the pH and increase solubility of phosphorus.

But, to recover this phosphorus excess CO₂ has to be removed. Aeration and mixing can be a good solution for bringing the pH to 7.0 by stripping out CO₂. NaOH has to be added to raise pH to 8.7.

e. NaOH

After the pH has been raised to neutral by aeration NaOH is needed to raise pH to facilitate struvite precipitation. Based on the data provided by MMSD, the average of total phosphorus content in dry sludge is **2.1%**.

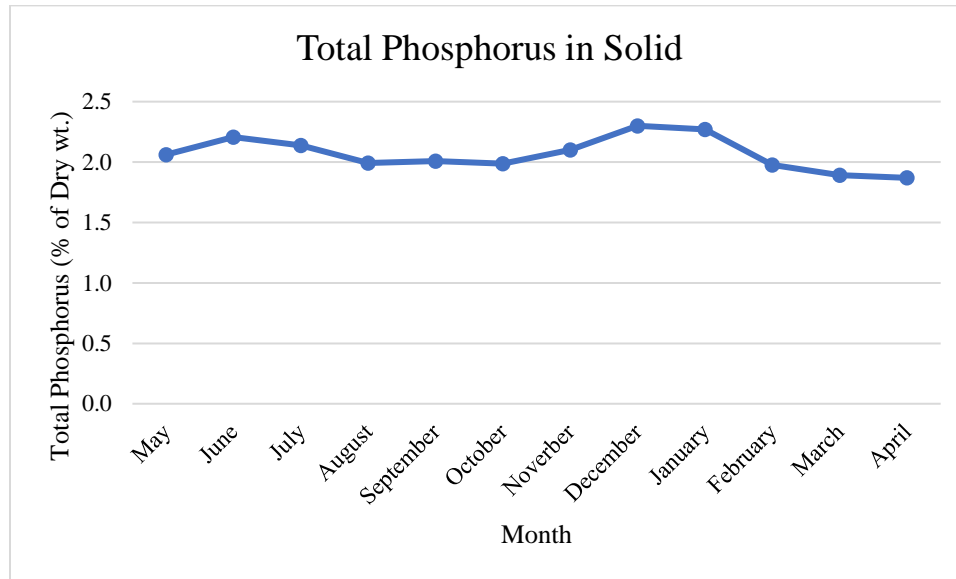

Figure 3. 13: Total Phosphorus in Sludge as % of Dry Weight [Source: MMSD]

Based on the Data provided by MMSD the solid content in the waste activated sludge (WAS) is ~1%. To achieve higher solid content thickening is necessary. The Total Solid content is 3.86% in WAS after thickening and 2% (simplified for 2.1%) of phosphorus is present in dry sludge.

Phosphorus concentration in secondary clarifier,

$$= 3000 \text{ lbs.} * 0.4536 / [3000 \text{ lbs.} * 0.4536 / (0.02)/0.0386]$$

$$= 772 \text{ mg/L}$$

And the WAS volume is 1762694L or 466,000 gallons.

According to Dhakal (2008), pH over 8.7 doesn't have an effect on phosphorus precipitation. The required NaOH to raise pH of the sludge from 7.0 to 8.6 [based on Figure 3.7] is

$$[\text{H}_3\text{O}^+] \text{ at pH } 7.0 = 10^{-7.0} * 1762694 = 0.1763 \text{ mol}$$

$$[\text{H}_3\text{O}^+] \text{ at pH } 8.6 = 10^{-8.6} * 1762694 = 0.0044 \text{ mol}$$

If 1M NaOH solution is used the volume of required NaOH,

$$= (0.1763 - 0.0044) * 1000 = 172 \text{ ml}$$

The mass of the NaOH,

$$C = \frac{1000w}{M * V}$$

$$w = 6.88 \text{ g} \quad \text{where, } C = \text{molar concentration} = 1\text{M}$$

$$M = \text{molar mass of NaOH} = 40 \text{ g}$$

$$V = \text{volume in ml} = 172 \text{ ml}$$

$$w = \text{mass of NaOH in g.}$$

Summary of simulation and calculation:

Biogas Waterwash

With 2 absorbers and 2 flashes at 40°C with water : gas = 1:4

@ 150 psi absorber pressure methane content = 98.7%

@ 87 psi absorber pressure methane content = 96.2%

@ 45 psi absorber pressure methane content = 98.8% [when water: gas = 1:1]

Phosphorus Recovery

Theoretical daily phosphorus recovery = 3000 lbs. or 23770 lbs. of Struvite

Carbon dioxide in total volume = 588 mg/L

Phosphorus in sludge = 772 mg/L

NaOH needed for sludge to raise pH at 8.6 = 6.88 g

Magnesium dose (MgO) = 141 mg/L. No additional Ammonia is necessary.

CHAPTER IV: PROPOSED MODIFICATION OF JIWWTP

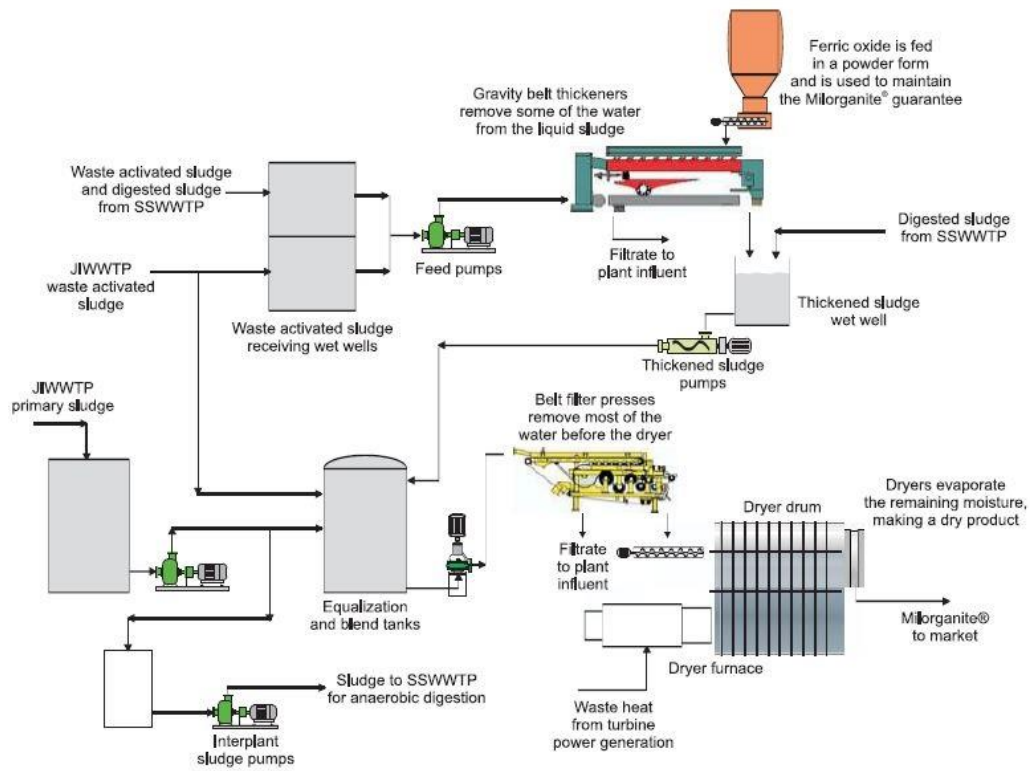

Figure 4. 1: Existing Jones Island Biosolids Facility [Source: MMSD]

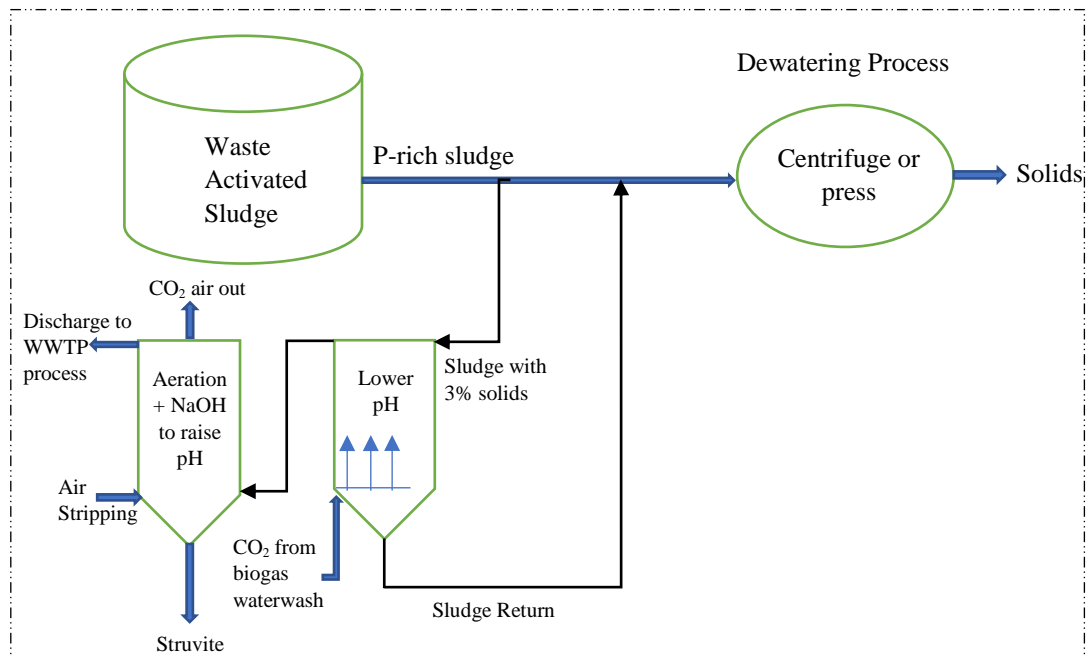

Figure 4. 2: Proposed Simplified Jones Island Biosolids Facility

As shown in Figure 4.1 existing biosolid facility in Jones Island WWTP uses Combined Enhanced Biological Phosphorus Removal with chemical addition where ferric oxide powder is mixed with sludge to improve phosphorus precipitation. The available data show that Milorganite has low phosphorus content and a modified biosolids facility has been proposed.

The proposed facility can use carbon dioxide with WAS to increase the solubility of phosphorus. After increased solubility is achieved, the carbon dioxide can be taken out by aeration and excess NaOH can be added to raise the pH. With a higher pH and favorable temperature more struvite can be collected. To raise pH, sufficient aeration is essential. Aeration alone can help in recovering 60 % of the struvite (Dhakal, 2008).

CHAPTER V: RESULTS AND DISCUSSION

Overall, this study shows that biogas upgrading is a promising technology with limited economic information and technical information. The production cost of biogas varies from 5% - 25% of the cost of product gas. The selection of upgrading technology depends on the highest purity that can be achieved. The factors related to economics are the investment, operating and maintenance costs. There are also technical factors, which influence the placement of biogas upgrading plants such as the demand for heat and power generation, an existing facility that produces large amounts of heat that could be utilized by the biogas process. MMSD has been using its biogas for heating purposes and the upgraded biogas can provide better heating with compact methane. Water wash is considered because of the location and availability of the biogas upgrading components. From an economic viewpoint large scale biogas upgrading plants are the most profitable and with 2000 cfm biogas MMSD can certainly be considered as a large-scale plant. Additionally, an upgraded methane of over 98% as the simulation suggests would certainly be a big incentive for a plant like Jones Island and based on previous works of Cozma et al. (2014), 96.6% methane can be obtained from water wash process which is a positive benchmark for the pending pilot.

Even though the goal was to utilize the system for large-scale plant, smaller plants were also considered in the study. The pilot simulation offers a better understanding of the process. For small-scale plants the lowest amount of gas that can be produced with the upgrading plant being economically viable is as low as 20 cfm. Small-scale plants are still popular and commonplace in Europe.

Considering the selected biogas upgrading technology's cost, the larger the plant size the cheaper the cost of production for the upgraded biomethane. Regardless of the process being used, the plant must be closed for maintenance once a year. In the United States biogas upgrading technology is not widely used. The use of carbon tax and better technological advancement can accelerate the process. Carbon taxes are in place in 14 countries in Europe to curb emissions from power plants and large industrial installations (Andersen, 2016). The carbon tax is not meant to be a punishment for industries rather obtains an economical leverage on industries to encourage a better and advanced emission practice. The use of tax and incentives are not unified across Europe and this should be

changed by member states as it is in the states' interest to increase the use of biomass for the production of vehicle fuel, heat and power.

Phosphorus recovery is important due to the discharge limit of 1 mg/L set by the DNR. But at present Jones Island using the technology from 1930s and Milorganite only has 2.88% phosphorus. Struvite is a better product as it has ammonia and magnesium as well, ingredients important for plant growth. Since wastewater treatment plants already have both ammonia and Mg in influent further addition is not required. But, the pH has to be raised and this work tried to establish a general scenario for those requirements for Jones Island WWTP.

Other than pH temperature is another factor related to struvite recovery and as described by Ohlinger & Mahmood (2003) a 10°C difference from 15 °C to 25 °C can increase the struvite collection by 25%. The effect of temperature has not been considered in this study because temperature in Wisconsin varies greatly and needs in depth analysis. The other important factor is, the recovery efficiency is not 100%. With a pH of 8.6 and preferable temperature usually 80-85% of phosphorus can be recovered which is satisfactory for environmental regulation set by DNR. The goal of this study was to integrate the gas purification process and phosphorus recovery process. The results are positive and with further analysis such an approach can be viable for Jones Island and other WWTPs in the Midwest.

In the summer of 2018 a pilot project has been approved and funded by MMSD to see if biogas water wash can be viable for Jones Island. The success of the pilot can help MMSD to upgraded gas supply and pave the way to test the phosphorus recovery technology.

REFERENCES

- Adresen, J. A., Hilberg, S. D., & Kunkel, K. E. (2014). Historical climate and climate trends in the Midwestern United States. *Climate Change in the Midwest: A Synthesis Report for the National Climate Assessment*, (March), 8–36.
- Allen, M. R., Braithwaite, A., & Hills, C. C. (1997). Trace Organic Compounds in Landfill Gas at Seven U.K. Waste Disposal Sites. *Environmental Science & Technology*.
<https://doi.org/10.1021/es9605634>
- Andersen, M. S. (2016). An Introductory Note on Carbon Taxation in Europe A Vermont Briefing, 1–6.
- Appels, L., Baeyens, J., Degrève, J., & Dewil, R. (2008). Principles and potential of the anaerobic digestion of waste-activated sludge. *Progress in Energy and Combustion Science*.
<https://doi.org/10.1016/j.pecs.2008.06.002>
- Arachchige, U. S. P. R., & Melaaen, M. C. (2012). Selection of Packing Material for Gas Absorption. *European Journal of Scientific Research*, 87(1), 1450–216. Retrieved from <http://www.europeanjournalofscientificresearch.com>
- Aspen Tech. (1999). Modelling Processes with Electrolytes. *Aspen*. Retrieved from <https://chemengr.ucsb.edu/~ceweb/courses/che184b/aspenplus/GettingStartedElectrolytes.ppt>
- Bauer, F., Hulteberg, C., Persson, T., & Tamm, D. (2013). Biogas upgrading – Review of commercial technologies. *Swedish Gas Technology Centre, SGC*, 82. [https://doi.org/SGC Rapport 2013:270](https://doi.org/SGC_Rapport_2013:270)
- Beil, M., & Beyrich, W. (2013). Biogas upgrading to biomethane. In *The Biogas Handbook: Science, Production and Applications*. <https://doi.org/10.1533/9780857097415.3.342>
- Biosling AB. (2012). *A new plant system for biogas upgrading on a small scale , farm size level*. Jukkasjärvi, Sweden. Retrieved from http://biosling.se/en/files/2012/11/productsheet_En.pdf

- Bortoluzzi, G., Gatti, M., Sogni, A., & Consonni, S. (2014). Biomethane production from agricultural resources in the Italian scenario: Techno-Economic analysis of water wash. *Chemical Engineering Transactions*, 37, 259–264. <https://doi.org/10.3303/CET1437044>
- Bradley, M. J. (n.d.). Natural Gas as a Transportation Fuel : Best Practices for Achieving Optimal Emissions Reductions.
- Britton, A., Koch, F. A., Mavinic, D. S., Adnan, A., Oldham, W. K., & Udala, B. (2005). Pilot-scale struvite recovery from anaerobic digester supernatant at an enhanced biological phosphorus removal wastewater treatment plant. *Journal of Environmental Engineering and Science*, 4(4), 265–277. <https://doi.org/10.1139/s04-059>
- Britton, A., Sacluti, F., Oldham, W. K., Mohammed, A., Mavinic, D. S., & Koch, F. A. (2007). Value from waste: struvite recovery at the city of Edmontons Gold Bar WWTP. *Proc. IWA Specialist Conference: Moving Forward - Wastewater Biosolids Sustainability.*, 575–581.
- Carlson, E. C. (1996). Don't gamble with physical properties for simulations. *Chemical Engineering Progress*.
- Carroll, J. J., & Mather, A. E. (1989). The solubility of hydrogen sulphide in water from 0 to 90°C and pressures to 1 MPa. *Geochimica et Cosmochimica Acta*. [https://doi.org/10.1016/0016-7037\(89\)90053-7](https://doi.org/10.1016/0016-7037(89)90053-7)
- Certification, W. O. (2009). Wisconsin Department of Natural Resources Wastewater Operator Certification Advanced Phosphorus Removal Study Guide, (January).
- Chapoy, A. (2004). *Phase behaviour in water/hydrocarbon mixtures involved in gas production systems*. Ecole des Mines de Paris.
- Chapoy, A., Mohammadi, A. H., Richon, D., & Tohidi, B. (2004). Gas solubility measurement and modeling for methane-water and methane-ethane-n-butane-water systems at low temperature conditions. *Fluid Phase Equilibria*. <https://doi.org/10.1016/j.fluid.2004.02.010>
- Coker, D. T., Freeman, B. D., & Fleming, G. K. (1998). Modeling multicomponent gas separation using hollow-fiber membrane contactors. *AIChE Journal*, 44(6), 1289–1302. <https://doi.org/10.1002/aic.690440607>

- Cozma, P., Wukovits, W., Mămăligă, I., Friedl, A., & Gavrilesco, M. (2014). Modeling and simulation of high pressure water scrubbing technology applied for biogas upgrading. *Clean Technologies and Environmental Policy*, 17(2). <https://doi.org/10.1007/s10098-014-0787-7>
- Cwm Harry Land Trust. (2013). *Feasibility study: Conversion of Struvite via gas infusion acidification*. Retrieved from <http://www.wrap.org.uk/>
- Czyperek, M., Zapp, P., Bouwmeester, H. J. M., Modigell, M., Ebert, K., Voigt, I., ... Stöver, D. (2010). Gas separation membranes for zero-emission fossil power plants: MEM-BRAIN. *Journal of Membrane Science*, 359(1–2), 149–159. <https://doi.org/10.1016/j.memsci.2010.04.012>
- Dean, J. A. (1990). Lange's handbook of chemistry. *Materials and Manufacturing Processes*. <https://doi.org/10.1080/10426919008953291>
- Department of Natural Resources. (2013). Chapter NR 217: effluent standards and limitations for phosphorus. *Effluent Standards and Limitations*, (217), 8 pp. Retrieved from http://water.epa.gov/scitech/swguidance/standards/wqslibrary/upload/wiwqs_nr217.pdf%5Cnhttp://nlquery.epa.gov/epasearch/epasearch?querytext=Chapter+NR+217&typeofsearch=area&cluster=no&areaname=WQS+Repository&filter=sample4filt.hts&fld=%7Cwater.epa.gov/sci
- Dhakal, S. (2008). A laboratory study of struvite precipitation for phosphorus removal from concentrated animal feeding operation wastewater, 86.
- Don, B. (2017). MMSD treated 99.8% of wastewater in 2016. *Milwaukee Journal Sentinel*. Retrieved from <https://www.jsonline.com/story/news/local/milwaukee/2017/01/05/mmsd-treated-998-wastewater-2016/96197894/>
- Doyle, J. D., Oldring, K., Churchley, J., Price, C., & Parsons, S. A. (2003). Chemical Control of Struvite Precipitation. *Journal of Environmental Engineering*. [https://doi.org/10.1061/\(ASCE\)0733-9372\(2003\)129:5\(419\)](https://doi.org/10.1061/(ASCE)0733-9372(2003)129:5(419))
- Dubois, L., & Thomas, D. (2012). Screening of Aqueous Amine-Based Solvents for Postcombustion CO₂ Capture by Chemical Absorption. *Chemical Engineering and Technology*, 35(3), 513–524. <https://doi.org/10.1002/ceat.201100523>

- DuPart, M. S., Bacon, T. R., & Edwards, D. J. (1993). Understanding corrosion in alkanolamine gas treating plants. *Hydrocarbon Processing*, 72(5), 89–94.
- Edwards, T. J., Maurer, G., Newman, J., & Prausnitz, J. M. (1978). Vapor-liquid equilibria in multicomponent aqueous solutions of volatile weak electrolytes. *AIChE Journal*.
<https://doi.org/10.1002/aic.690240605>
- Eide-Haugmo, I., Lepaumier, H., Einbu, A., Vernstad, K., Da Silva, E. F., & Svendsen, H. F. (2011). Chemical stability and biodegradability of new solvents for CO₂ Capture. *Energy Procedia*, 4, 1631–1636. <https://doi.org/10.1016/j.egypro.2011.02.034>
- EPA. (1999). Method TO-13A: Determination of Polycyclic Aromatic Hydrocarbons (PAHs) in Ambient Air Using Gas Chromatography / Mass Spectrom. *Environmental Protection Agency*, (April), 2–4.
- EPA. (2015). *The 2014 Annual Effluent Guidelines Review Report*. Washington, DC.
<https://doi.org/EPA-821-R-16-002>
- Evans, T. D., & Lane, P. (2006). Recovering ammonium and struvite fertilisers from digested sludge dewatering liquors. *IWA Specialist Conference: Moving Forward–Wastewater Biosolids Sustainability*, (June), 713–722.
- Gaffney, J. S., & Marley, N. A. (2009). The impacts of combustion emissions on air quality and climate - From coal to biofuels and beyond. *Atmospheric Environment*.
<https://doi.org/10.1016/j.atmosenv.2008.09.016>
- Gamba, S., & Pellegrini, L. A. (2013). Biogas upgrading: Analysis and comparison between water and chemical scrubbing. *Chemical Engineering Transactions*, 32, 1273–1278.
<https://doi.org/10.3303/CET1332213>
- Götz, M., Köppel, W., Reimert, R., & Graf, F. (2012). Optimierungspotenzial von Wäschen zur Biogasaufbereitung. *Chemie-Ingenieur-Technik*. <https://doi.org/10.1002/cite.201100129>
- Harasek, M. (2006). Biogas upgrading with membrane separation process. Retrieved June 10, 2018, from http://membran.at/Biogasaufbereitung_mit_Membrantrennverfahren

- Hine, J., & Mookerjee, P. K. (1975). The Intrinsic Hydrophilic Character of Organic Compounds. Correlations in Terms of Structural Contributions. *Journal of Organic Chemistry*. <https://doi.org/10.1021/jo00891a006>
- Hudde, J. (2010). Experience with the Application of Water Scrubbing Biogas Upgrading Technology: On the Road with CNG and Biomethane European Best Practice Examples: The Madagascar Project. In *The Madagascar Project Final Conference*. Prague, Czech Republic.
- Hunter, P., & Oyama, S. T. (2000). *Control of Volatile Organic Compound Emissions: Conventional and Emerging Technologies*. New York: John Wiley & Sons.
- IPCC. (2008). 2006 IPCC Guidelines for National Greenhouse Inventories – A primer, Prepared by the National Greenhouse Gas Inventories Programme., *Intergovernmental Panel on Climate Change National Greenhouse Gas Inventories Programme*, 20.
- IPNI. (2018). *Nutrient Source Specifics*. Norcross, GA. Retrieved from <http://www.ipni.net/specifics>
- Jacob, D. J. (1986). Chemistry of OH in remote clouds and its role in the production of formic acid and peroxymonosulfate. *Journal of Geophysical Research*. <https://doi.org/10.1029/JD091iD09p09807>
- Jaffrin, A., Bentounes, N., Joan, A. M., & Makhlof, S. (2003). Landfill biogas for heating greenhouses and providing carbon dioxide supplement for plant growth. *Biosystems Engineering*. [https://doi.org/10.1016/S1537-5110\(03\)00110-7](https://doi.org/10.1016/S1537-5110(03)00110-7)
- Jönsson, O., Polman, E., Jensen, J. K., Eklund, R., Schyl, H., & Ivarsson, S. (2003). Sustainable gas enters the european gas distribution system. *Danish Gas Technology Center*, 1–9.
- Kavanaugh, M. C., & Trussell, R. R. (1980). Design of aeration towers to strip volatile contaminants from drinking water. *Journal / American Water Works Association*.
- Kohl, A., & Nielsen, R. (1997). *Gas Purification*. Houston, TX: Gulf Publishing Company.

- Lallemand, F., Perdu, G., Matetto, C., Weiss, C., Magne-Drisch, J., & Lucquin, A. C. (2012). Solutions for the treatment of highly sour gases: Process technologies for the cost-effective treatment of natural gas with high and ultra-high acid gas content. Retrieved June 1, 2018, from http://www.digitalrefining.com/article/1000356,Solutions_for_the_treatment_of_highly____sour_gases.html#.WxzhaUgvxPY
- Latimer, R., Hanson, T., Khunjar, W., & Pitt, P. (2012). Nutrient Recovery as a Green Technology for Managing Phosphorus Removal. *Texas WET*, (May/June), 17–21.
- Lekvam, K., & Bishnoi, P. R. (1997). Dissolution of methane in water at low temperatures and intermediate pressures. *Fluid Phase Equilibria*. [https://doi.org/10.1016/S0378-3812\(96\)03229-3](https://doi.org/10.1016/S0378-3812(96)03229-3)
- Lelieveld, J., & Crutzen, P. J. (1991). The role of clouds in tropospheric photochemistry. *Journal of Atmospheric Chemistry*. <https://doi.org/10.1007/BF00048075>
- Lepaumier, H., Picq, D., & Carrette, P. L. (2009). Degradation study of new solvents for CO₂ capture in post-combustion. *Energy Procedia*, 1(1), 893–900. <https://doi.org/10.1016/j.egypro.2009.01.119>
- Li, H., Yan, J., & Campana, P. E. (2012). Feasibility of integrating solar energy into a power plant with amine-based chemical absorption for CO₂ capture. *International Journal of Greenhouse Gas Control*, 9(July), 272–280. <https://doi.org/10.1016/j.ijggc.2012.04.005>
- Lide, D. R. (1998). *CRC Handbook of Chemistry and Physics* (79th ed.). CRC Press, Inc.
- Lide, D. R. (2003). *CRC Handbook of Chemistry and Physics*, 84th Edition, 2003-2004. *Handbook of Chemistry and Physics*. <https://doi.org/10.1136/oem.53.7.504>
- Lomans, B. P., Pol, A., & Op den Camp, H. J. (2002). Microbial cycling of volatile organic sulfur compounds in anoxic environments. *Water Science and Technology*.
- Maasackers, J. D., Jacob, D. J., Sulprizio, M. P., Turner, A. J., Weitz, M., Wirth, T., ... Fischer, M. L. (2016). Gridded National Inventory of U.S. Methane Emissions. *Environmental Science and Technology*, 50(23), 13123–13133. <https://doi.org/10.1021/acs.est.6b02878>

- Mackay, D., & Shiu, W. Y. (1981). A critical review of Henry's law constants for chemicals of environmental interest. *Journal of Physical and Chemical Reference Data*.
<https://doi.org/10.1063/1.555654>
- Mao, S., Duan, Z., Zhang, D., Shi, L., Chen, Y., & Li, J. (2011). Thermodynamic modeling of binary CH₄-H₂O fluid inclusions. *Geochimica et Cosmochimica Acta*.
<https://doi.org/10.1016/j.gca.2011.07.021>
- Marzouk, S. A. M., Al-Marzouqi, M. H., El-Naas, M. H., Abdullatif, N., & Ismail, Z. M. (2010). Removal of carbon dioxide from pressurized CO₂-CH₄ gas mixture using hollow fiber membrane contactors. *Journal of Membrane Science*. <https://doi.org/DOI:10.1016/j.memsci.2010.01.023>
- Mazari, S. A., Si Ali, B., Jan, B. M., Saeed, I. M., & Nizamuddin, S. (2015). An overview of solvent management and emissions of amine-based CO₂ capture technology. *International Journal of Greenhouse Gas Control*. <https://doi.org/10.1016/j.ijggc.2014.12.017>
- Merkel, T. C., Lin, H., Wei, X., & Baker, R. (2010). Power plant post-combustion carbon dioxide capture: An opportunity for membranes. *Journal of Membrane Science*, 359(1–2), 126–139. <https://doi.org/10.1016/j.memsci.2009.10.041>
- Millero, F. J., Hubinger, S., Fernandez, M., & Garnett, S. (1987). Oxidation of H₂S in Seawater as a Function of Temperature, pH, and Ionic Strength. *Environmental Science and Technology*. <https://doi.org/10.1021/es00159a003>
- Münch, E. v., Benesovsky-Scott, A., Josey, J., & Barr, K. (2001). *Making a Business from Struvite Crystallisation from Waste Water Treatment: Turning Waste into Gold*. Brisbane, Australia.
- Murray, B. C., Galik, C. S., & Vegh, T. (2014). Biogas in the United States: An Assessment of Market Potential in a Carbon-Constrained Future., (February), 1–59. <https://doi.org/NI R14-02>
- Nelson, N. O., Mikkelsen, R. L., & Hesterberg, D. L. (2003). Struvite precipitation in anaerobic swine lagoon liquid: Effect of pH and Mg:P ratio and determination of rate constant. *Bioresource Technology*, 89(3), 229–236. [https://doi.org/10.1016/S0960-8524\(03\)00076-2](https://doi.org/10.1016/S0960-8524(03)00076-2)

- NETL. (2013). *Cost and Performance Baseline for Fossil Energy Plants Volume 1: Bituminous Coal and Natural Gas to Electricity*. National Energy Technology Laboratory.
<https://doi.org/DOE/NETL-2010/1397>
- Ohlinger, K., & Mahmood, R. (2003). Struvite Scale Potential Determination Using a Computer Model. *World Water & Environmental Resources Congress 2003*, (916), 1–9.
[https://doi.org/10.1061/40685\(2003\)267](https://doi.org/10.1061/40685(2003)267)
- Ohlinger, K. N. (1999). *Struvite controls in anaerobic digestion and postdigestion wastewater treatment processes*. University of California, Davis, Calif.
- ÖKOBIT GmbH. (2014). The Biogas Upgrading Processes. Retrieved May 15, 2018, from
<https://www.oekobit-biogas.com/>
- Persson, M. (2003). Evaluation of Upgrading Techniques for Biogas. *Environmental Engineering*. <https://doi.org/SGC142>
- Persson, M., Jonsson, O., & Wellinger, A. (2007). Biogas Upgrading To Vehicle Fuel Standards and Grid Injection. *IEA Bioenergy*, 1–32.
- Petersson, A., & Wellinger, A. (2009). Biogas upgrading technologies—developments and innovations. *IEA Bioenergy*. <https://doi.org/10.1016/j.wasman.2011.09.003>
- Pierantozzi, R. (2003). Carbon Dioxide. In *Kirk-Othmer Encyclopedia of Chemical Technology*. John Wiley & Sons, New York.
- Rasi, S. (2009). *Biogas Composition and Upgrading to Biomethane Saija Rasi Biogas Composition and Upgrading to Biomethane*. <https://doi.org/978-951-39-3607-5>
- Rehling, C. J., & Truog, E. (1939). Activated sludge--Milorganite. *Industrial & Engineering Chemistry Analytical Edition*, 11(5), 281–283. <https://doi.org/10.1021/ac50133a017>
- Rhoades, George D. Golueke, R. J. (1993). *US5390499A*. United States.
- Ryckebosch, E., Drouillon, M., & Vervaeren, H. (2011). Techniques for transformation of biogas to biomethane. *Biomass and Bioenergy*. <https://doi.org/10.1016/j.biombioe.2011.02.033>
- Sander, R. (2011). Carbon dioxide: Henry's Law data. Retrieved June 5, 2018, from
<https://webbook.nist.gov/cgi/cbook.cgi?ID=C124389&Mask=10#Solubility>

- Scheutz, C., Mosbaek, H., & Kjeldsen, P. (2004). Attenuation of methane and volatile organic compounds in landfill soil covers. *Journal of Environmental Quality*.
<https://doi.org/10.2134/jeq2004.0061>
- SEPA. (2004). *Guidance on gas treatment technologies for landfill gas engines Lfd Statement of Use*. Bristol, UK. Retrieved from <https://www.sepa.org.uk/media/28989/ep165-part-1-guidance-on-gas-treatment-technologies-for-landfill-gas-engines.pdf>
- Severn Wye Energy Agency. (2013). Introduction to the Production of A Guide for England and Wales, 46.
- Shin, H. C., Park, J. W., Park, K., & Song, H. C. (2002). Removal characteristics of trace compounds of landfill gas by activated carbon adsorption. *Environmental Pollution*.
[https://doi.org/10.1016/S0269-7491\(01\)00331-1](https://doi.org/10.1016/S0269-7491(01)00331-1)
- Singh, P. (1979). *Amine Based Solvent for CO 2 Absorption From Molecular Structure to Process*. <https://doi.org/10.3990/1.9789036532006>
- Sjöstrand, F., & Yazdi, R. (2009). Absorption of CO 2 Diploma work.
- Sohrabi, M. R., Marjani, A., Moradi, S., Davallo, M., & Shirazian, S. (2011). Mathematical modeling and numerical simulation of CO2 transport through hollow-fiber membranes. *Applied Mathematical Modelling*, 35(1), 174–188.
<https://doi.org/10.1016/j.apm.2010.05.016>
- Starr, K., Gabarrell, X., Villalba, G., Talens, L., & Lombardi, L. (2012). Life cycle assessment of biogas upgrading technologies. *Waste Management (New York, N.Y.)*.
<https://doi.org/10.1016/j.wasman.2011.12.016>
- Stoddart, J., Zhu, M., Staines, J., E., R., & Lewicki, R. (1999). Experience with Halogenated Hydrocarbons Removal from Landfill Gas. In *Seventh International Waste Management and Landfill Symposium* (p. Volume II: 489-498). Cagliari, Sardinia, Italy.
- Stoessell, R. K., & Byrne, P. A. (1982). Salting-out of methane in single-salt solutions at 25°C and below 800 psia. *Geochimica et Cosmochimica Acta*. [https://doi.org/10.1016/0016-7037\(82\)90268-X](https://doi.org/10.1016/0016-7037(82)90268-X)

- Strigle, R. F. (1994). *Packed tower design and applications: random and structured packings* (2nd ed.). Houston, TX: Gulf Pub. Co.
- Suda, H., & Haraya, K. (1997). Gas Permeation through Micropores of Carbon Molecular Sieve Membranes Derived from Kapton Polyimide. *The Journal of Physical Chemistry B*, *101*(20), 3988–3994. <https://doi.org/10.1021/jp963997u>
- Torkkeli, A. (2003). Droplet microfluidics on a planar surface. *VTT Publications*, *52*(504), 3–194. <https://doi.org/10.1002/aic>
- Ueno, Y., & Fujii, M. (2001). Three years experience of operating and selling recovered struvite from full-scale plant. *Environmental Technology (United Kingdom)*. <https://doi.org/10.1080/09593332208618196>
- United Nations. (1992). United Nations Framework Convention on Climate Change. *Fccc/Informal/84*, *1*(3), 270–277. <https://doi.org/10.1111/j.1467-9388.1992.tb00046.x>
- Vinnerås, B., Schönning, C., & Nordin, A. (2006). Identification of the microbiological community in biogas systems and evaluation of microbial risks from gas usage. *Science of the Total Environment*, *367*(2–3), 606–615. <https://doi.org/10.1016/j.scitotenv.2006.02.008>
- Walsh, K. (2018, April 25). Typical Climate of the Midwestern United States. *USA Today*. Retrieved from <http://traveltips.usatoday.com/typical-climate-midwestern-united-states-103926.html>
- Wang, Z., Ren, H., Zhang, S., Zhang, F., & Jin, J. (2018). Carbon Molecular Sieve Membranes Derived from Tröger's Base-Based Microporous Polyimide for Gas Separation. *ChemSusChem*, *11*(5), 916–923. <https://doi.org/10.1002/cssc.201702243>
- Wilber, C., & Murray, C. (1990). Odor source evaluation. *BioCycle*, *31*(3), 68–72.
- Wilhelm, E., Battino, R., & Wilcock, R. J. (1977). Low-Pressure Solubility of Gases in Liquid Water. *Chemical Reviews*. <https://doi.org/10.1021/cr60306a003>
- Williams, R. B., Kaffka, S. R., & Oglesby, R. (2014). DRAFT INTERIM PROJECT REPORT DRAFT Comparative Assessment of Technology Options for Biogas Clean - up.

Wisconsin DNR. (2009). Wisconsin Department of Natural Resources Wastewater Operator Certification Introduction to Phosphorus Removal Study Guide, (January).

XEBEC. (2012). Product Range - Biogas Upgrading, www.xebexinc.com, 2(450), 8700.
Retrieved from <http://www.xebecinc.com/pdf/Biogas-Reference-Installations.pdf>

Yaws, C. L. (1999). *Chemical Properties Handbook: Physical, Thermodynamic, Environmental, Transport, Safety, and Health Related Properties for Organic and Inorganic Chemicals*. McGrawHill handbooks. <https://doi.org/http://dx.doi.org/10.1016/B978-075067766-0/50019-1>

Zhao, Q., Leonhardt, E., MacConnell, C., Frear, C., & Chen, S. (2010). Purification Technologies for Biogas Generated by Anaerobic Digestion. *Climate Friendly Farming: Improving the Carbon Footprint of Agriculture in the Pacific Northwest*. CSANR Research Report 2010-00.

Zheng, D. Q., Guo, T. M., & Knapp, H. (1997). Experimental and modeling studies on the solubility of CO₂, CHClF₂, CHF₃, C₂H₂F₄ and C₂H₄F₂ in water and aqueous NaCl solutions under low pressures. *Fluid Phase Equilibria*. [https://doi.org/10.1016/S0378-3812\(96\)03177-9](https://doi.org/10.1016/S0378-3812(96)03177-9)